



170.MAN.MEM.2D1 01/0



USER MANUAL

**MEMOCAL
2000**

CONTENTS

SECTION 1 GENERAL INFORMATION

1.1 INTRODUCTION	Page 4
1.2 PRODUCT SPECIFICATIONS	4
1.3 SERIAL INTERFACE	11
1.4 SEQUENTIAL FUNCTION ROUTINE	11
1.5 SPECIAL FUNCTIONS	11
1.6 CODING	12
1.7 IDENTIFICATION LABEL	12

SECTION 2 INSTRUMENT CONFIGURATION

2.1 FRONT PANEL DESCRIPTION	13
2.2 KEYBOARD DESCRIPTION	14
2.3 INSTRUMENT CONFIGURATION	16

SECTION 3 OPERATING INSTRUCTIONS

3.1 PRELIMINARY	19
3.2 TC MEASUREMENT	21
3.3 RTD MEASUREMENT	23
3.4 mA MEASUREMENT	24
3.5 TX MEASUREMENT	29
3.6 mV MEASUREMENT	33
3.7 OHM MEASUREMENT	37
3.8 TC SIMULATION	38
3.9 RTD SIMULATION	41

3.9 mA GENERATION	42
3.10 TX SIMULATION	46
3.11 mV GENERATION	51
3.12 OHM SIMULATION	56

SECTION 4 SEQUENTIAL FUNCTION ROUTINE

4.1 HOW TO CONSTRUCT AND STORE A NEW SEQUENTIAL FUNCTION ROUTINE	58
4.2 HOW TO MODIFY A ROUTINE	60
4.3 HOW TO RUN A ROUTINE	61

SECTION 5 ERROR MESSAGES

5.1 LOAD ERRORS	63
5.2 ERROR MESSAGES	64

SECTION 6 MAINTENANCE

6.1 POWER SUPPLY	65
6.2 BATTERY RECHARGE	66
6.3 BATTERY MAINTENANCE	67
6.4 BATTERY REPLACEMENT	67
6.5 HOW TO CLEAN THE INSTRUMENT	67
6.6 INTERNAL FUSES	67
6.7 INSTRUMENT MAINTENANCE	67



CAUTIONS:

- 1) The AC adapter is intended for indoor use only.
- 2) To avoid electric shock, do not use the AC adapter close to steam generator or water basin.
- 3) Before connecting the AC adapter to the power line, verify the integrity of the adapter case. If the case is damaged, replace it.



SECTION 1 GENERAL INFORMATION

1.1 INTRODUCTION

The MEMOCAL 2000 is a versatile, portable, hand-held calibrator developed to solve two different and coexisting customer needs: field calibration (maintenance) and laboratory calibration (maintenance, quality test, process simulation, training, etc..).

- The field calibration requires small dimensions, no additional accessories, long battery life, ergonomics, friendly interface, low temperature drift, high noise immunity and simple programming capabilities.
- The laboratory requires: interface for data loggers or supervision and control systems, large range of I/O capabilities, high accuracy and stability over time.

The features listed below give an idea of the possible applications and use facility offered by this instrument

- Accuracy 0.015 % (*)
- Temperature drift 0.1 $\mu\text{V}/^\circ\text{C}$
- Operates with standard 1.5 V AA type alkaline batteries or rechargeable batteries (Ni-Cd or Ni-MH)
- Advanced battery power management for circuit stand-by mode when not in use.
- 24 hours (average) battery life operation.
- Built in bi-directional RS-232 interface for remote programming and data recording
- Autoranging during measurement **and generation**.
- Simulates and measures T/C signals (15 T/C type) and RTD signals (Pt 100 and Ni 100).
- Generates and measures mA, mV, V and OHM signals.

- Square root extraction and quadratic signal generation.
- Programmable scaling for mA, mV and V measurement and generation.
- Built in 24 V DC power supply for 2-wires transmitter excitation and measurement.
- Programmable external cold junction compensation value.
- Peak and valley data hold.
- Direct connection for all input types (no special connectors are required for TC inputs).
- Up to 50 steps program or smaller programs to total of 50 steps.
- Ramp, soak and step function capability
- 2 dry contact logic inputs for program advance/wait.

1.2 PRODUCT SPECIFICATIONS

1.2.1 GENERAL SPECIFICATIONS

Case: ABS grey case, color similar to RAL 6038.

Case protection: IP 20.

Terminal: 3 external screw FEMALE plugs ϕ 4 mm.

Input protection: all measured and generated ranges are protected against fault connection to signals up to 30 V AC/DC.

Display: 2 rows by 16 characters alphanumeric back lighted LCD display

Weight: 600 g. max. (1.4 lb.).

Power supply: 4 batteries AA size :

- Alkaline 1,5 V or
- Ni-Cd 1,2 V or
- Ni-H 1.2 V.

Battery life: 24 hours (average) with Ni-MH batteries.
Recharging time: 12 hours
AC/DC adapter: input: from 100 to 250 V AC, 47 to 73 Hz, 100 mA.
output: 7.5 V, 1.2 A DC.
Insulation resistance: > 100 MΩ according to IEC 348.
Isolation voltage: 1500 V r.m.s. according to IEC 348.
Electromagnetic compatibility and safety requirements:
This instrument is marked CE.
Therefore, it is conforming to council directives 89/336/EEC
(reference harmonized standard EN 50081-2 and EN 50082-2) and
to council directives 73/23/EEC and 93/68/EEC (reference har-
monized standard EN 61010-1).
Installation category: II
D/A conversion: dual slope integration.
Resolution: ± 20000 counts
Common mode rejection ratio: 120 dB @ 50/60 Hz.
Normal mode rejection ratio: 60 dB @ 50/60 Hz.
Sampling time: 500 ms.
Display update time: 500 ms.
Temperature drift: 0.0028 %/°C or 28 ppm/°C (CJ excluded).
Operating temperature: from 0 to +40 °C.
Storage temperature: from -10 to +60 °C.
Humidity : from 20% to 85 % RH non condensing.
Protections: WATCH DOG circuit for automatic restart.

1.2.2 INPUTS

A) THERMOCOUPLE MEASUREMENT

Type : B, E, J, K, L, N, Ni/Ni-18%Mo, PLII, R, S,T, U, W, W3 and W5 keyboard programmable.

Engineering unit: °C or °F keyboard programmable.

Burn out : Detection of the open input circuit (wires or sensor) with "OPEN" indication.

Cold junction: automatic compensation from 0 to 45 °C.

Cold junction compensation error: ± 0.3 °C ± 0.005 °C/°C
(± 0.5°F ± 0.005 °F/°F).

External cold junction compensation: programmable

- from -20 °C to +80 °C or -4.0 °F to 176.0 °F for TC type J, K, T, E, R, S, U, L, PLII;
- from 0 °C to 80 °C or from 32 °F to 176 °F for TC type B, N, Ni/Ni18%Mo, W, W3 and W5).

Input impedance:> 10 MΩ.

External resistance: 100 Ω max, maximum error 0,1% of span.

Calibration: according to IPTS-68 or ITS 90 programmable

Standard range table when the engineering unit is equal to °C

TC type	RANGE	RESOL.	Max. Error (CJ excl.)
J	-200°C to 1200 °C	0,1 °C	0.2 °C
K	-200°C to 967 °C	0,1 °C	0.3 °C
	968°C to 1370 °C	< 0,2 °C	0.5 °C
T	-200°C to 0 °C	0,1 °C	0.3 °C
	1 °C to 400 °C	0,1 °C	0.1 °C

TC type	RANGE	RESOL.	Max. Error (CJ excl.)
E	-200°C to 1000 °C	0,1 °C	0.2 °C
R	-50°C to 0 °C	< 0,3 °C	1.4 °C
	1°C to 350 °C	< 0,2 °C	0.9 °C
	351°C to 1684 °C	0,1 °C	0.4 °C
	1685°C to 1760 °C	< 0,2 °C	0.7 °C
S	-50°C to 0 °C	< 0,3 °C	1.1 °C
	1°C to 600 °C	< 0,2 °C	0.9 °C
	601°C to 1760 °C	0,1 °C	0.4 °C
B	50°C to 100 °C	< 3 °C	12.4 °C
	101°C to 200 °C	< 1 °C	4.1 °C
	201°C to 600 °C	< 0,5 °C	1.9 °C
	601°C to 1150 °C	0,2 °C	0.7 °C
	1151°C to 1820 °C	0,1 °C	0.4 °C
U (*)	-200°C to 600 °C	0,1 °C	0.2 °C
L (*)	-200°C to 900 °C	0,1 °C	0.3 °C
N	0°C to 1410 °C	< 0,2 °C	0.5 °C
Ni/Ni 18%Mo	0°C to 1300 °C	0,1 °C	0.3 °C
PLII	-100°C to 961 °C	0,1 °C	0.2 °C
	962°C to 1400 °C	< 0,2 °C	0.6 °C

(*) Available only when IPTS-68 standard is selected

TC type	RANGE	RESOL.	Max. Error (CJ excl.)
W (G)	0°C to 50 °C	< 1 °C	2.9 °C
	51°C to 100 °C	< 0,3 °C	1.1 °C
	101°C to 250 °C	< 0,2 °C	0.8 °C
	251°C to 1530 °C	0,1 °C	0.4 °C
	1531°C to 2300 °C	< 0,2 °C	1.4 °C
W3 (D)	0°C to 100 °C	0,1 °C	0.4 °C
	101°C to 1090 °C	0,1 °C	0.3 °C
	1091°C to 2310 °C	< 0,3 °C	1.0 °C
W5	0°C to 1096 °C	0,1 °C	0.3 °C
	1097°C to 2250 °C	0,2 °C	0.9 °C
	2251°C to 2315 °C	< 0,3 °C	1.0 °C

Standard range table when the engineering unit is equal to °F

TC type	RANGE	RESOL.	Max. Error (CJ excl.)
J	-328 °F to 1382 °F	0,1 °F	0.5 °F
K	-328 °F to 32 °F	< 0,2 °F	0.5 °F
	33 °F to 1772 °F	0,1 °F	2.0 °F
	1773 °F to 2264 °F	0,1 °F	0.6 °F
T	2265 °F to 2498 °F	< 0,3 °F	0.9 °F
	-328 °F to 32 °F	< 0,2 °F	0.5 °F
	33 °F to 752 °F	0,1 °F	0.2 °F

TC type	RANGE	RESOL.	Max. Error (CJ excl.)
E	-328 °F to 1832 °F	0,1 °F	0.4 °F
R	-58 °F to 32 °F	< 0,5 °F	2.6 °F
	33 °F to 350 °F	< 0,4 °F	1.6 °F
	351 °F to 500 °F	< 0,3 °F	1.2 °F
	501 °F to 3062 °F	< 0,2 °F	0.8 °F
	3063 °F to 3214 °F	< 0,3 °F	1.2 °F
S	-58 °F to 32 °F	< 0,5 °F	2.0 °F
	33 °F to 140 °F	< 0,4 °F	1.6 °F
	141 °F to 470 °F	< 0,3 °F	1.2 °F
	471 °F to 3214 °F	< 0,2 °F	0.8 °F
B	122 °F to 212 °F	< 4 °F	14.9 °F
	213 °F to 320 °F	< 2 °F	5.0 °F
	321 °F to 600 °F	<1 °F	2.4 °F
	601 °F to 1250 °F	< 0,5 °F	1.2 °F
	1251 °F to 1770 °F	< 0,3 °F	0.8 °F
	1771 °F to 3276 °F	<0,2 °F	0.5 °F
U (*)	-328 °F to 1112 °F	0,1 °F	0.4 °F
L (*)	-328 °F to 1299 °F	0,1 °F	0.3 °F
	1300 °F to 1652 °F	< 0,2 °F	0.5 °F

(*) Available only when IPTS-68 standard is selected

TC type	RANGE	RESOL.	Max. Error (CJ excl.)
N	32 °F to 1083 °F	< 0,2 °F	0.4 °F
	1084 °F to 2006 °F	0,1 °F	0.7 °F
	2007 °F to 2570 °F	< 0,2 °F	0.8 °F
Ni/Ni 18%Mo	32 °F to 1529 °F	0,1 °F	0.5 °F
	1530 °F to 2372 °F	< 0,2 °F	0.5 °F
PLII	-148 °F to 924 °F	0,1 °F	0.4 °F
	925 °F to 1761 °F	< 0,2 °F	0.4 °F
	1762 °F to 2552 °F	< 0,3 °F	1.1 °F
W (G)	32 °F to 392 °F	< 1,2 °F	5.2 °F
	393 °F to 1292 °F	< 0,2 °F	0.9 °F
	1293 °F to 2309 °F	0,1 °F	0.7 °F
	2310 °F to 2786 °F	0,2 °F	0.7 °F
	2787 °F to 3276 °F	< 0,3 °F	0.7 °F
W3 (D)	32 °F to 572 °F	< 0,2 °F	0.8 °F
	573 °F to 1832 °F	0,1 °F	0.6 °F
	1833 °F to 1994 °F	< 0,2 °F	0.6 °F
	1995 °F to 3276 °F	< 0,3 °F	1.7 °F
W5	32 °F to 572 °F	< 0,2 °F	0.6 °F
	573 °F to 1958 °F	< 0,3 °F	1.6 °F
	1959 °F to 3276 °F	< 0,4 °F	1.8 °F

B) RTD (Resistance Temperature Detector) MEASUREMENT

RTD type: - Pt 100 3 wire connection.

- Ni 100 3 wire connection.

Calibration: according to DIN 43760

Line resistance: Up to 20 Ω /wire with no measurable error.

Engineering unit: $^{\circ}\text{C}$ or $^{\circ}\text{F}$ keyboard programmable.

Measuring current: 100 μA .

Burn out: Detection of the sensor open circuit and one or more wires open circuit.

Calibration: according to IPTS-68 or ITS 90 programmable

Standard range table for RTD Pt 100

RANGES (Pt 100)	RESOL.	Max. Error
-200 $^{\circ}\text{C}$ to 850 $^{\circ}\text{C}$	0,1 $^{\circ}\text{C}$	0.294 $^{\circ}\text{C}$
-328 $^{\circ}\text{F}$ to 512 $^{\circ}\text{F}$	0,1 $^{\circ}\text{F}$	0.227 $^{\circ}\text{F}$
513 $^{\circ}\text{F}$ to 1562 $^{\circ}\text{F}$	< 0,2 $^{\circ}\text{F}$	0.548 $^{\circ}\text{F}$

Standard range table for RTD Ni 100

RANGES (Ni 100)(*)	RESOL.	Max. Error
-60 $^{\circ}\text{C}$ to 350 $^{\circ}\text{C}$	0,1 $^{\circ}\text{C}$	0.119 $^{\circ}\text{C}$
-76 $^{\circ}\text{F}$ to 662 $^{\circ}\text{F}$	0,1 $^{\circ}\text{F}$	0.217 $^{\circ}\text{F}$

(*) Available only when IPTS-68 standard is selected.

C) mA AND mV MEASUREMENT

Ranges: see table below

Resolution: see table below

Reference accuracy: the accuracy is shown as a percent of the specified span.

Range selection: Automatic or manual.

Input impedance:

10 Ω for mA input

> 10 $\text{M}\Omega$ for mV inputs

> 500 $\text{k}\Omega$ for V input

Square root extraction: programmable

Read-out: keyboard programmable from -20000 to 20000.

Decimal point: programmable in any position.

Standard range table

RANGES	RESOL.	ACCUR.	Max. Error
-20 mV to 20 mV	1 μV	$\pm 0.015\%$	0.006 mV
-200 mV to 200 mV	10 μV	$\pm 0.015\%$	0.060 mV
-2 V to 2 V	100 μV	$\pm 0.015\%$	0.001 V
-20 V to 20 V	1 mV	$\pm 0.020\%$	0.008 V
-20 mA to 20 mA	1 μA	$\pm 0.015\%$	0.006 mA
-130 mA to 130 mA	10 μA	$\pm 0.020\%$	0.052 mA

D) TX MEASUREMENT

The TX measurement is a mA measurement with a 24 V power supply generated by the instrument and is used to calibrate 2, 3 or 4-wire transmitters.

Power supply: 24 V DC (maximum current 24 mA)

Resolution: 1 μ A.

Reference accuracy: 0.015 %

Input impedance: 10 Ω for mA input

Input range: 0 to 20 mA

Square root extraction: programmable

Read-out: keyboard programmable from -20000 to 20000.

Decimal point: programmable in any position.

E) Ω MEASUREMENT

Ranges: from 0 to 800 Ω .

Resolution: 0.1 Ω .

Reference accuracy: the accuracy is shown as a percent of the specified span.

Standard range table

RANGES	RESOL.	ACCUR.
0 Ω to 800 Ω	0,1 Ω	\pm 0.025 %

1.2.3 OUTPUTS

A) THERMOCOUPLE SIMULATIONS

Type : B, E, J, K, L, N, Ni/Ni-18%Mo, PLII, R, S,T, U, W, W3 and W5 keyboard programmable.

Engineering unit: $^{\circ}$ C or $^{\circ}$ F keyboard programmable.

Output impedance: 100 Ω .

Calibration: according to IPTS-68 or ITS 90 programmable.

Standard ranges: For ranges, accuracies and resolutions see the thermocouples input tables.

B) RTD (Resistance Temperature Detector) SIMULATION

RTD type: - Pt 100 3 wire connection.

- Ni 100 3 wire connection.

Calibration: according to DIN 43760

Engineering unit: $^{\circ}$ C or $^{\circ}$ F keyboard programmable.

Measuring current: 100 μ A < measuring current < 2 mA.

Burn out: Detection of the reverse measuring current and of a wrong measuring current.

Calibration: according to IPTS-68 or ITS 90 programmable.

Standard range table for RTD Pt 100

RANGES (Pt 100)	RESOL.	Max. Error
-200 $^{\circ}$ C to 850 $^{\circ}$ C	0,1 $^{\circ}$ C	0.305 $^{\circ}$ C
-328 $^{\circ}$ F to 512 $^{\circ}$ F	0,1 $^{\circ}$ F	0.416 $^{\circ}$ F
513 $^{\circ}$ F to 1562 $^{\circ}$ F	< 0,2 $^{\circ}$ F	0.473 $^{\circ}$ F

Standard range table for RTD Ni 100

RANGES (Ni 100)(*)	RESOL.	Max. Error
-60 °C to 350 °C	0,1 °C	0.148 °C
-76 °F to 680 °F	0,1 °F	0.194 °F

(*) Available only when IPTS-68 standard is selected.

C) mA AND mV GENERATION

Ranges: see table below

Range selection: Automatic or manual.

Output impedance: 100 Ω for mV outputs
0.5 Ω for V output

Maximum load for mA output: 500 Ω .

Quadratic signal generation: programmable

Read-out: keyboard programmable from -20000 to 20000.

Decimal point: programmable in any position.

Reference accuracy: the accuracy is shown as a percent of the specified span.

Standard range table

RANGES	RESOL.	ACCUR.	Max. Error
-4 mV to 20 mV	1 μ V	± 0.015 %	0.004 mV
-40 mV to 200 mV	10 μ V	± 0.015 %	0.036 mV
-400 mV to 2000mV	100 μ V	± 0.015 %	0.360 mV
-4 V to 20 V	1 mV	± 0.020 %	0.005 V
0 mA to 21 mA	1 μ A	± 0.015 %	0.003 mA

D) Ω SIMULATION

Ranges: from 15 to 500 Ω .

Resolution: 0.1 Ω .

Reference accuracy: the accuracy is shown as a percent of the specified span.

Standard range table

RANGES	RESOL.	ACCUR.
15 Ω to 500 Ω	0,1 Ω	± 0.031 %

E) LOGIC INPUTS

The MEMOCAL 2000 is equipped with 2 logic inputs.

They are mutually exclusive with serial interface.

These 2 logic inputs have the following functions:

- 1) Logic input 1: sequences to the next program step.
- 2) Logic input 2: it allows to start or to suspend the program execution (RUN/WAIT).

1.3 SERIAL INTERFACE (optional)

Types:

- Built in: RS-232C.
- External: RS-232 to RS 485 opto-isolated converter installed in the desk-top-stand.

Protocol type: MODBUS, JBUS.

Baud rate: keyboard programmable from 600 to 19200 BAUD.

Byte format: 8 bit.

Parity: even, odd or none programmable.

Stop bit: one.

Address: from 1 to 255.

Output voltage levels: according to EIA standard.

1.4 SEQUENTIAL FUNCTION ROUTINE

This instrument is provided of 50 steps which can be utilized to make up one or more programs.

Each program can encompass a free number of soke and ramp simulations, measurements and stand by steps.

1.5 SPECIAL FUNCTIONS

Backlight: LED backlighting with manual ON and automatic (30 seconds) shut OFF.

Self diagnostic: at instrument start up.

Peak detection: minimum and maximum Peak Picker.

LOW BATTERY TEST

A test is provided at 3 different levels:

- 1) **Level 1:** the instrument is fully operative.
- 2) **Level 2:** the instrument shows the message "BATTERY LOW" on the upper display while the lower display shows the measured or generated value.
The instrument is still fully operative.
- 3) **Level 3:** the instrument turns OFF automatically and utilizes the remaining power for memory back up only.

1.6 CODING

STANDARD EQUIPMENT

CODE	Description
MEM.200.000.000	Hand held calibrator with AC adapter (100 to 240 V AC switching type) and 4 Ni-Cd rechargeable batteries.
MEM.200.0RS.000	Hand held calibrator with built-in RS-232 interface, connection cable for PC, AC adapter and 4 Ni-Cd rechargeable batteries.
MEM.200.000.100	Hand held calibrator with AC adapter (100 to 240 V AC switching type), 4 Ni-Cd rechargeable batteries and leather bag.
MEM.200.0RS.100	Hand held calibrator with built-in RS-232 interface, connection cable for PC, AC adapter, 4 Ni-Cd rechargeable batteries and leather bag.

OPTIONAL EQUIPMENTS

CODE	Description
08M.024.000.000	Leather bag for MEMOCAL 2000
MEM.200.0DT.000	Desk-top-stand with RS-232/RS-485 converter (isolated) and battery fast recharge capability.
MEM.200.0BA.TT1	Kit 4 Ni-Ca rechargeable batteries.
MEM.200.0CA.BL0	Connection cable for PC.

1.7 IDENTIFICATION LABEL

The instrument identification label is located externally on the housing.

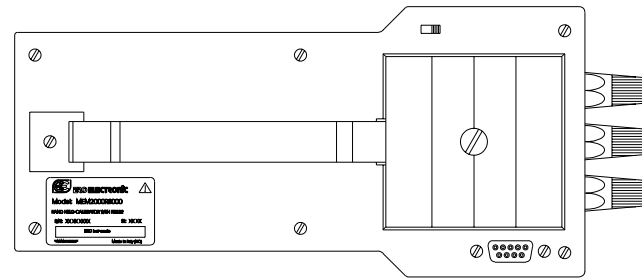

It contains the following information:

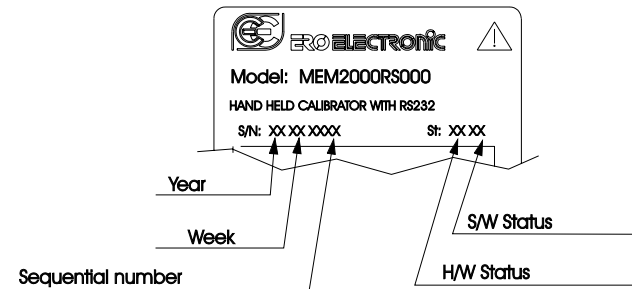

SECTION 2 INSTRUMENT CONFIGURATION

2.1 FRONT PANEL DESCRIPTION



2.2 KEYBOARD DESCRIPTION



It allows to turn ON or OFF the instrument.



This key has 2 different functions:



- 1) When the instrument operates in NORMAL DISPLAY MODE, a fast depression of the push-button will turn ON or OFF the display backlighting. The instrument has an internal 30 seconds time out, 3 sec only when battery is "low". If no one of the push-buttons have been depressed in the meantime, then the backlighting will turn OFF automatically.
- 2) By keeping depressed this push-button for 1,5 seconds the instrument returns in STAND BY mode.

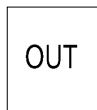

It is used to start a measuring sequence.



It is used to start a generating sequence.

Push-button from  to  are used to set all the numerical values.

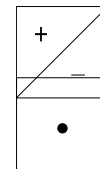

It sets the sign of the numerical value (for numerical data entry in generation and for scalable values)

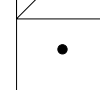

It inserts the decimal point (for numerical data entry in generation and for scalable values).



During setting procedures, this key allows the storage of the desired value or the desired menu selection and then to step to the next parameter. During program execution, this key allows to jump to the next program step.



During setting procedures, it allows scrolling back the menu selection without storage of settings. During program execution, this key allows to jump immediately to the previous program step.



During measurement, it is used to display the maximum peak value. By depressing it a second time, it toggles to the normal measured value. During generation, by keeping it depressed, it

overimposes a ramp to the generated value with a gradient of 1 LSD for each 1/2 second; by depressing it once, the generated output will increase of 1 LSD.
 During a selection procedure, it is used to move the cursor forward.



During measurement, it is used to display the minimum peak value.
 By depressing it a second time, it toggles to the normal measured value.
 During generation, by keeping it depressed, it overimpose a ramp to the generated value with a gradient of 1 LSD for each 1/2 second; by depressing it once, the generated output will decrease of 1 LSD.
 During a selection procedure, it is used to move the cursor backward.



During editing of a numerical value, it deletes the typed value.
 During program editing, it deletes the whole program, a single step or a numerical value.
 While a program is running, this push-button, once depressed, enables/disables the WAIT function.



Used to select the desired program for running, editing or deleting



During a scaled measurement or a scaled generation, it is used to revert the display from the normalized value to the actual electrical value and vice versa.
 During program editing it is used to modify the program.



This push-button is used for instrument set up.
 During program editing, it inserts a new program step.



During measurement, they allow to clear the memory of the maximum peak value.

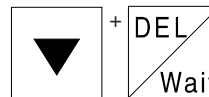

During measurement, they allow to clear the memory of the minimum peak value.



During measurement, they allow to clear both of the above.

2.3 INSTRUMENT CONFIGURATION

At the first start up of the instrument or when it is desired to modify a configuration parameter proceed as follows.
 The instrument should be in STAND BY mode or in NORMAL DISPLAY MODE.
 Depress the SET UP/INS push-button. The display will show the following:

```

OPEN INPUT TEST?
  YES      NO
  
```

This instrument is capable to performing, during TC and RTD measurement, an open input test (the instrument injects a 100 μ A impulse signal).
 When this test is desired, select YES and depress the FUNC push-button.
 The display will show:

```

SERIAL LINK
DIGITAL INP NONE
  
```

SERIAL LINK
 To enable the serial communication.
DIGITAL INP
 To enable the logic inputs.
NONE

Both options are disabled.

2.3.1 SERIAL LINK

RS-232 connection diagram

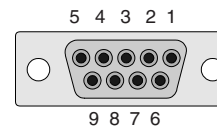

Pin	Description
1	RESERVED
2	- RS232 receiver data (RX) - Logic input 1 (step advance)
3	RS232 transmitter data (TX)
4	Positive voltage for logic input
5	Signal ground for RS232
6	RESERVED
7	RTS Request to send (used by the RS 232/RS485 converter).
8	Logic input 2 (RUN/WAIT)
9	RESERVED

WARNING: to avoid damage to the instrument, pin 1, 6 and 9 must be ever disconnected (we suggest the use of the "connection cable for PC" supplied with the instrument)

Selecting the SERIAL LINK and depressing the FUNC push-button, the display will show the following:

AD	XX	BR	XXXXXX
XBUS		PA	XXXX

where:

AD is the address of the serial communication interface (from 1 to 255).

BR is the communication baud rate (600, 1200, 2400, 4800, 9600, 19200).

XBUS Shows the desired communication protocol (MBUS = Mode bus or JBUS = Jbus).

PA is the communication parity control (NONE, EVEN, ODD).
With the ▲ or ▼ push-buttons modify the numerical values, while, with FUNC push-button, go to the following field.

2.3.2 DIGITAL INPUTS

WARNING: to avoid damage to the instrument, pin 1, 6 and 9 must be ever disconnected.

DIGITAL INPUT 1

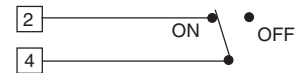

During a sequential function routine execution, when the instrument detects a transition from OFF to ON of the logic input 1, it will stop to execute the actual step and will start immediately to execute the next step (STEP ADVANCE) of the selected sequential function routine.

DIGITAL INPUT 2

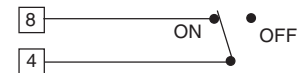

During a sequential function routine execution, it allows to stop (WAIT) or to continue (RUN) the routine execution.
When the logic input 2 is in ON condition, the routine execution is in WAIT status.
When the logic input 2 is in OFF condition, the routine execution is in RUN status.

NOTE: when the logic inputs are selected, the WAIT function can be enabled/disabled by logic input 2 only.

2.3.3 NONE

When NONE is selected no option will be used and the instrument goes automatically to the next configuration step

The configuration procedure is completed and the instrument will memorize the new configuration parameters and goes automatically to the STAND BY mode.

NOTE: It is possible to stop the configuration procedure in any moment by pushing SET UP/INS pushbutton. The instrument will memorize the new setting followed by FUNC pushbutton pressure and it will use the old values for all the other parameters.

After option selection and its parameter setting, the display will show the following:

```
DEFAULT ENG. UNIT
°C  °F
```

Select the desired default engineering unit.
Depressing the FUNC push-button.

The display will show the following:

```
TEMP. STANDARD
IPTS-68  ITS-90
```

Select the derired standard for TC and RTD measure and generation.
Depressing the FUNC push-button.

SECTION 3 - OPERATING INSTRUCTIONS

3.1 PRELIMINARY

- 1) In order to assure the maximum accuracy of the instrument it is necessary to perform a 3 minutes warm-up period before to start to calibrate.
- 2) For all TC measurements and simulations and for mV measurements and generations it is suggested to connect the cables directly to the instrument connectors without any additional plug. If plugs are required, it is necessary to use gold plated banana plugs in order to avoid not desired junctions between the cables and the plug material.
- 3) For all ranges, it is suggested to use No 20 AWG (0,597 mm²) or larger wires.

3.1.1 OPERATIVE MODE

At power up, the instrument starts in stand by mode (warm-up with low power consumption) and the display will show:

```
MEMOCAL 2000
STAND BY
```

The instrument may be operative in one of the 5 following modes:

- 1) STAND BY (warm-up with low power consumption)
- 2) MEASURE (it is performing a measure)
- 3) GENERATION (it is performing a generation)

- 4) RUN (it is running a routine).
- 5) EDIT (the user is editing a routine).

In the following pages each mode will be described completely.

3.1.2 GENERAL NOTES

- 1) The I/O impedance of the instrument will be equal to:
 - a) high impedance (>500 KOhm) for STAND BY mode, EDIT mode, mV, V or TC measurement;
 - b) low impedance for mA measurement and Ohm simulation;
 - c) current injection for resistance or RTD measurement;
 - d) low impedance with 24 V power supply for TX measurement.
 - e) During RUN mode the I/O impedance will be in accordance with the programmed action.
- 2) When the transfer from MEAS to OUT is requested, the instrument goes automatically in STAND BY mode in order to assure an high impedance during instrument connection.

3.1.3 GENERAL NOTES ON GENERATIONS

- 1) During generation, when a new value is desired, it is sufficient to type directly the new value using the numerical keyboard and to push the FUNC push-button. The instrument will start immediately to generate the new value.
- 2) By pushing ▲ or ▼ push-button, the generated value will be increased or decreased of 1 LSD.
- 3) By pushing continuously ▲ or ▼ push-button, the generated value will change with a rate equal to 2 LSD/second.
- 4) When, typing a value, an error occurs, push the DEL push-button and retype the desired value.

- 5) When a negative value is desired, it is possible to depress the [+/-] push-button at any time during data entry procedure.
- 6) Setting a numerical value out of the selected range, the instrument will show "E" and it will continue to generate the old value.
- 7) Setting a value with a number of decimal figures higher than the selected range, the instrument will truncate the programmed value according to the number of decimal figures of the selected range.
- 8) When it is selected a generation with automatic range selection and a value higher than 20000 counts is programmed (the decimal point position have no influence), the instrument will show the "E" message and it will continue to generate the old value.

NOTE: only the OUT 20 mA NON RANGEABLE selection allows to set a (and to generate) a value up to 21.000 mA.

GENERAL NOTES ON MEASUREMENTS

- 1) During a measurement, the maximum and minimum data hold functions are enabled.
These functions are activated automatically by measuring function.
To display the maximum and minimum data hold push, respectively, the ▲ and ▼ push-button.
The instrument will show, on the right hand of the value, the PKH message when the maximum data hold value is shown or PKL message when the minimum data hold is shown.
When it is desired to clear the values of the maximum or minimum data hold previously memorized, push the DEL/WAIT push-button and, maintaining the pressure, push, respectively, the ▲ or ▼ push-button.
- 2) The instrument incorporates, for mV, mA and TX measurements with programmable scaling, a special function REV/MODE that allows to display, temporarily, the measured value without scaling (in mV or mA).
To enable or disable this function push the REV/MODE push-button.

3.2 TC MEASUREMENTS

- NOTES:** 1) to enable/disable the open input test, see the paragraph "2.3 INSTRUMENT CONFIGURATION".
2) The instrument will operate in accordance to the selected temperature standard (IPTS-68 or ITS-90) (see paragraph "2.3 INSTRUMENT CONFIGURATION").

CONNECTION FOR TC MEASUREMENTS USING INTERNAL RJ

For all TC measurements it is suggested to connect the cables directly to the instrument connectors without any additional plug. If plugs are required, it is necessary to use gold plated banana plugs in order to avoid not desired junction effects between cables and plug material.

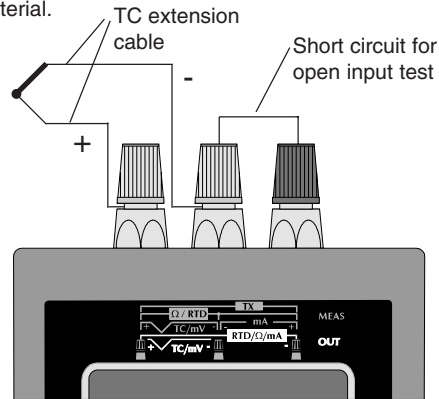

CONNECTION FOR TC MEASUREMENTS USING EXTERNAL RJ

When a TC with external stable reference junction box is used, connect the copper cable of the stable reference junction box to the instrument and set the external reference junction compensation value as shown below.

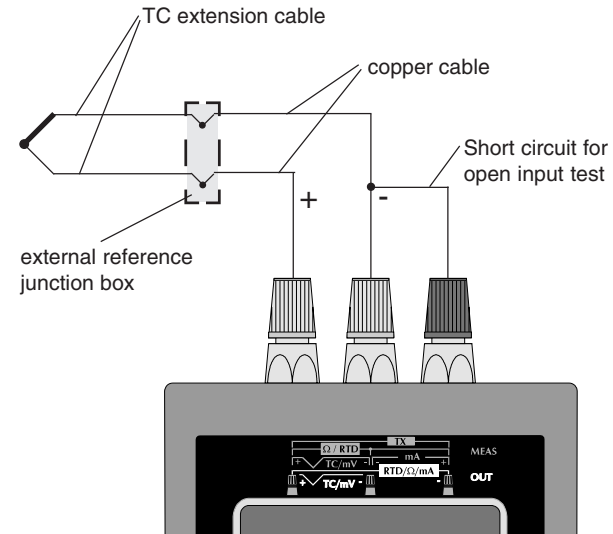

HOW TO MEASURE A TEMPERATURE USING A TC SENSOR

Depress the MEAS push-button, the display will show the following:

```
MEAS
TC RTD mA mV TX
```

By ▲ or ▼ push-buttons select the desired input sensor, that is "TC".

Push the FUNC push-button; the display will show the following:

```
K J L E T U W W3
S R B N P Nm W5
```

By depressing the ▲ or ▼ push-buttons select the desired TC type (e.g. J).

NOTE: when ITS-90 is selected, the TC type U and L are not available so that the instrument will show this two TC type with a small letter and it does not allow to select it by jumping the two symbols during the cursor scroling.

Depress the FUNC push-button again the display will show the following:

```
ENGINEERING UNIT
°C °F
```

By pushing the ▲ or ▼ push-buttons select the desired engineering unit (e.g. °C).

Push the FUNC push-button; the display will show the following:

```
CJ INT
CJ EXT XXXXX
```

Depressing the ▲ or ▼ push-button, select the desired cold junction compensation type (external or internal) (e.g. INT).

NOTE

A) When the internal cold junction compensation has been selected, the instrument uses an internal RTD to compensate the ambient temperature (from 0 to 45 °C or from 32 to 113 °F) and it starts immediately to display the measured value.

B) If, otherwise, the external cold junction compensation has been selected, the instrument requires to insert the external reference junction compensation value (the temperature of the external reference junction compensation box).

This value can be programmed:

- from -20 °C to +80 °C or -4.0 °F to 176.0 °F for TC type J, K, T, E, R, S, U, L, PLII;
- from 0 °C to 80 °C or from 32 °F to 176 °F for TC type B, N, Ni/Ni18%Mo, W, W3 and W5 .

By the numerical keyboard, set the desired compensation value (if no value is inserted, the instrument will use a value equal to 0 °C or 32 °F according to the engineering unit previously selected).

Push the FUNC push-button, the instrument will show the following:

```
MEAS 68J E 25.0
XXXXXXXX °C
```

Where :

- MEAS shows that the instrument is performing a measurement.
- 68 shows that the selected standard is the IPTS-68
- J shows that the input sensor is a TC type J.
- E shows that an external compensation has been selected
- 25.0 shows the selected compensation value.
- XXXXXXXX This field displays the measured value in engineering units.
- °C shows the selected engineering unit.

3.3 RTD MEASUREMENTS

NOTE: The instrument will operate in accordance to the selected temperature standard (IPTS-68 or ITS-90) (see paragraph "2.3 INSTRUMENT CONFIGURATION").

CONNECTION FOR RTD MEASUREMENTS

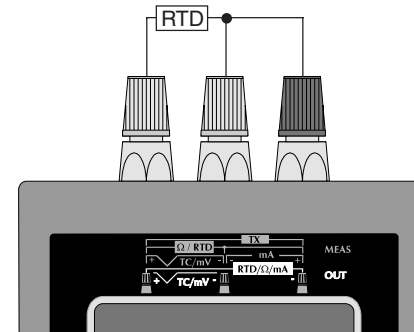

HOW TO MEASURE A TEMPERATURE USING AN RTD SENSOR

Push MEAS push-button; the display will show the following:

```
MEAS
TC RTD mA mV TX
```

By pushing ▲ or ▼ push-button, select the desired input type, that is "RTD".

Push the FUNC push-button; the display will show:

```
Pt100  Ni100
Ohm
```

By pushing ▲ or ▼ push-button, select the desired RTD type (e.g. Pt100).

NOTE: when ITS-90 is selected, the RTD type Ni 100 is not available so that the instrument will show this RTD with small letters and it does not allow to select it.

Push the FUNC push-button; the display will show the following:

```
ENGINEERING UNIT
°C  °F
```

Depressing ▲ or ▼ push-button, select the desired engineering unit (e.g. °C).

Depress the FUNC push-button; the display will show the following:

```
MEAS 68 Pt100
XXXXXXXX °C
```

where:

- MEAS shows that the instrument is performing a measurement
- 68 shows that the selected standard is the IPTS-68
- Pt100 shows that the input sensor is an RTD Pt 100.
- XXXXXXXX it shows the measured value.
- °C shows the selected engineering unit.

3.4 - mA MEASUREMENT.

CONNECTION FOR mA MEASUREMENTS WITHOUT AUXILIARY POWER SUPPLY.

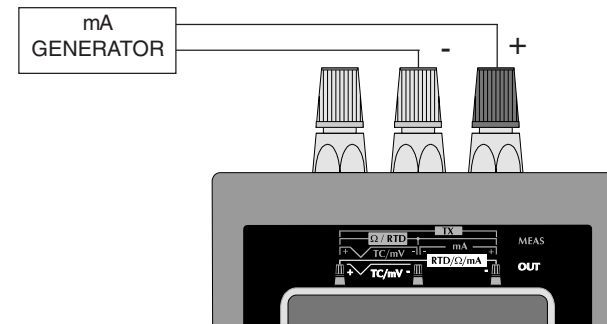

NOTE: The MEMOCAL 2000 Input impedance is equal to 10 Ω.

HOW TO MEASURE A mA SIGNAL

Push the MEAS push-button; the display will show:

```
MEAS
TC RTD mA mV TX
```

Pushing ▲ or ▼ push-button select the desired input type, that is "mA".
 Push the FUNC push-button; the display will show the following:

```

NON - RANGEABLE
RNG (L)  RNG (√)
  
```

Where:

NON - RANGEABLE

allows to select a mA measurement without scaling (with a read-out in mA).

RNG(L)

allows to select a mA input with read-out scaling (the read-out is expressed in engineering unit and not in mA).

RNG(√)

allows to select a mA input with square root extraction on the measured value and programmable read-out scale in engineering units.

3.4.1 - NON RANGEABLE - mA measurement without scaling

Pushing ▲ or ▼ push-button, select the NON RANGEABLE input type.

Push the FUNC push-button.

The display will show:

```

20  200
AUTO
  
```

Where :

20, 200 show the selectable 20mA, 200mA fix ranges.

Note: the 200 mA is limited at 130 mA.

When a fixed range is selected the instrument will use a fix decimal figures.

AUTO

indicates that the instrument automatically selects the proper input range in order to measure the input signal with the max. possible resolution.

Pushing ▲ or ▼ push-button select the desired input range (e.g. AUTO)

Push the FUNC push-button.

The instrument starts measuring and the display will show:

```

MEAS      AUTO
XXXXXX mA
  
```

Where:

MEAS indicates that the instrument is performing a measurement.

AUTO shows that the autoranging function is selected.

mA is the engineering unit.

XXXXX shows the measured value.

3.4.2 - RNG(L) linear mA measurement with read-out scaling.

The **RNG(L)** selection allows to associate to an input range the desired read-out range.

Example 1: with a linear input range from 0 to 20 mA it is desired to have a read-out going from -10.000 to 10.000 (m/s).

Pushing ▲ or ▼ push-button, select the desired function, that is RNG (L).

Push the FUNC push-button, the display will show the following:

```
L . RNG XXXXX $\bar{\text{X}}$  mA
L . RNG XXXXXX EU
```

By the numerical keyboard, set the desired initial scale value (For Example 1, this value is equal to 0.000 mA).

NOTES:

- 1) The value assigned to "H.RANGE mA" must be higher than the value assigned to "L.RANGE mA" parameter.
- 2) The value assigned to "H.RANGE EU" parameter must be different from the value assigned to "L.RANGE EU".

When conditions 1 or 2 are not satisfied, the instrument will reject the new value showing the "0" and it will maintain the cursor on the rejected parameter.

- 3) The value assigned to "H.RANGE EU" parameter can be lower than the value assigned to "L.RANGE EU" (reverse read-out).

Push the FUNC push-button; the cursor will go automatically to the lower line.

By the numerical keyboard, set the desired read-out assigned to the initial scale value (For Example 1, it is equal to -10.000 m/s). Depress the FUNC push-button.

NOTES: For the read-out in eng. units, the number of decimal figures is free with respect of the read-out limits (20000 counts). The display will show the following:

```
H . RNG XXXXX $\bar{\text{X}}$  mA
H . RNG XXXXXX EU
```

By the numerical keyboard, set the desired final scale value (For Example 1, this value is equal to 20.000 mA).

Push the FUNC push-button.

By the numerical keyboard, set the desired read-out assigned to the final scale value (For Example 1 this value is equal to 10.000 m/s).

Push the FUNC push-button.

NOTE For the read-out in eng. units, the number of decimal figures will be equal to the decimal figure programmed in "L.RNG EU".

The instrument will start to measure and, for Example 1, if a 3 mA signal is applied to the input terminal the display will show:

MEAS RNG (L) mA
-3.000 EU

NOTES:

- 1) The instrument will automatically select the input range containing the two programmed values ("L.RANGE mA" and "H.RANGE mA") with the maximum resolution.
- 2) During mA measurement with programmable read-out scaling it is possible to enable/disable, by the REV/MOD push-button, the scaling function and to display the measured value in mA.
- 3) During mA measurement, the instrument is able to measure and display up to 5 % more than the upper programmed value or 5% less than the lower programmed value.

3.4.3 - RNG ($\sqrt{\quad}$) - mA measurement with square root extraction and linear read-out scaling.

Selecting the **RNG** ($\sqrt{\quad}$) option, the instrument extracts the square root of the measured value and scales it according to the programmed range.

Example 2 : with a quadratic input range from 4 to 20 mA it is desired to have a read-out going from 5.00 to 200.00 (m³/h).

Pushing ▲ or ▼ push-button, select the RNG($\sqrt{\quad}$) function.

Push the FUNC push-button, the display will show the following:

L . RNG XXXXX $\sqrt{\quad}$ mA
L . RNG XXXXXX EU

By the numerical keyboard, set the desired initial scale value (For Example 2 it is equal to 4.000 mA).

NOTES:

- 1) The value assigned to "H.RANGE mA" must be higher than the value assigned to "L.RANGE mA" parameter.
 - 2) The value assigned to "H.RANGE EU" parameter must be different from the value assigned to "L.RANGE EU".
- When conditions 1 or 2 are not satisfied, the instrument will reject the new value showing the "0" and it will maintain the cursor on the rejected parameter.
- 3) The value assigned to "H.RANGE EU" parameter can be lower than the value assigned to "L.RANGE EU" (reverse read-out).

Push the FUNC push-button; the cursor will go automatically to the lower line.

By the numerical keyboard, set the desired read-out assigned to the initial scale value (For Example 2, it is equal to 5.00 m³/h.) Depress the FUNC push-button.

NOTES:

- 1) The input range may contain negative values.
- 2) The displayed range will only be represented with positive numbers.

The display will show the following:

H . RNG	XXXXXX	mA
H . RNG	XXXXXX	EU

By the numerical keyboard, set the desired final scale value (For Example 2 it is equal to 20.000 mA).

Push the FUNC push-button.

By the numerical keyboard, set the desired read-out assigned to the final scale value (For Example 2 it is equal to 200.00 (m³/h)). Push the FUNC push-button.

NOTES:

- 1) For the read-out in eng. units, the number of decimal figures will be equal to the decimal figure programmed in "L.RNG EU".
- 2) For the read-out in eng. units, the number of decimal figures is free with respect of the read-out limits (20000 counts).

The instrument will start to measure and, for Example 2, if a 7 mA signal is applied to the input terminal the display will show:

MEAS	RNG (√) mA
86.71	EU

NOTES:

- 1) The instrument will automatically select the input range containing the two programmed values ("L.RANGE mA" and "H.RANGE mA") with the maximum resolution.
- 2) During mA measurement with programmable read-out scaling it is possible to enable/disable, by the REV/MOD push-button, the scaling function and to display the measured value in mA.
- 3) During mA measurement, the instrument is able to measure and display up to 5 % more than the upper programmed value or 5% less than the lower programmed value.

3.5 - TX MEASUREMENT

NOTE: we define as TX all the 2, 3 or 4 -wire transmitters with 20 mA output capability.

The instrument generates a 24 V (max 25 mA) auxiliary power supply for the transmitters in subject.

CONNECTION FOR TX MEASUREMENTS FROM 2-WIRE TRANSMITTER WITH 24 V POWER SUPPLY.

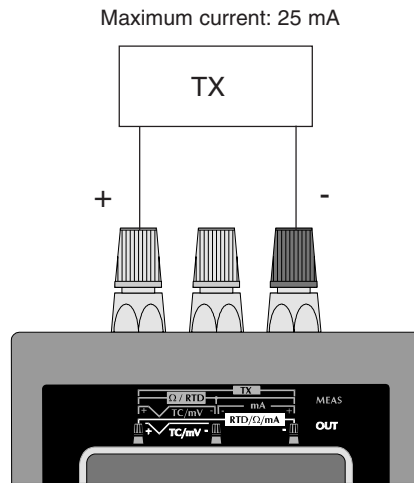

CONNECTION FOR TX MEASUREMENTS FROM 3 OR 4-WIRE TRANSMITTER WITH 24 V POWER SUPPLY.

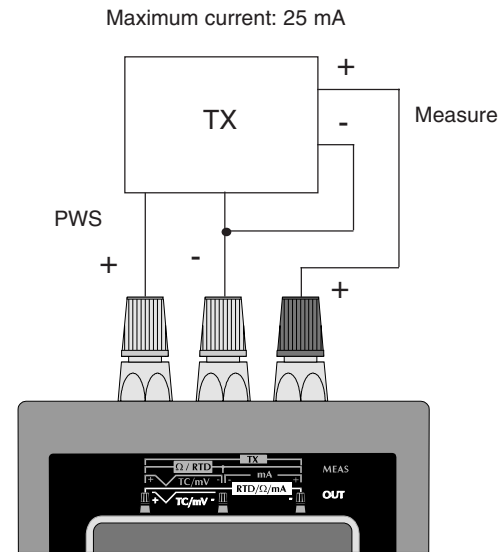

HOW TO EXECUTE A TX MEASUREMENT.

Push the MEAS push-button; the display will show:

```
MEAS
TC RTD mA mV TX
```

Pushing ▲ or ▼ push-button, select the TX measurement.
Push the FUNC push-button; the display will show the following:

```
RNG (L)
RNG (√)
```

Where:

RNG(L)

means a linear input with programmable read-out scale in engineering units.

RNG(√)

means a square root extraction of the measured value with programmable read-out scale in engineering units .

3.5.1 RNG (L) TX measurement with linear input and read-out scaling.

Example 1: with a linear input range from 4 to 20 mA it is desired to have a read-out going from 1.00 to 10.00 (Bar).

Pushing ▲ or ▼ push-button select the RNG(L) scaling type.

Push the FUNC push-button, the display will show the following:

```
L . RNG XXXXXx mA
L . RNG XXXXXX EU
```

By the numerical keyboard, set the desired initial scale value (from Example 1, this value is equal to 4.000 mA).

NOTES:

- 1) The value assigned to "H.RANGE mA" must be higher than the value assigned to "L.RANGE mA" parameter.
- 2) The value assigned to "H.RANGE EU" parameter must be different from the value assigned to "L.RANGE EU".

When conditions 1 or 2 are not satisfied, the instrument will reject the new value showing the "0" and it will maintain the cursor on the rejected parameter.

- 3) The value assigned to "H.RANGE EU" parameter can be lower than the value assigned to "L.RANGE EU" (reverse read-out).

Push the FUNC push-button; the cursor will go automatically on the lower line.

By the numerical keyboard, set the desired read-out assigned to the initial scale value (from Example 1 this value is equal to 1.00 Bar).

Depress the FUNC push-button.

NOTES: The instrument uses the 20 mA input range.

For the read-out in eng. units, the number of decimal figures is free with respect of the read-out limits (20000 counts).

The display will show the following:

```
H . RNG XXXXX  mA
H . RNG XXXXXX EU
```

By the numerical keyboard, set the desired final scale value (From Example 1, this value is equal to 20.000 mA).

Push the FUNC push-button; the cursor will go automatically on the lower line.

By the numerical keyboard, set the desired read-out assigned to the final scale value (from Example 1 this value is equal to 10.00 Bar).

NOTE: For the read-out in eng. units, the number of decimal figures will be equal to the decimal figure programmed in "L.RANGE EU".

Push the FUNC push-button.

The instrument will start to measure .

For example 1, if a signal equal to 13.067 mA is applied to the input terminal the display will show:

```
MEAS TX (L)
6 . 10 EU
```

NOTES:

- 1) During a TX measurement it is possible to enable/disable, by the REV/MOD push-button, the scaling function and to display the measured value in mA. For the previous indication the instrument will show:

```
MEAS 20 mA
13.067 mA
```

- 2) During TX measurement, the instrument is able to measure and display up to 5 % more than the upper programmed value or 5% less than the lower programmed value.

3.5.2 RNG ($\sqrt{\quad}$) TX measurement with square root extraction on the measured value and programmable read-out scaling.

Selecting the **RNG** ($\sqrt{\quad}$) option, the instrument extracts the square root of the measured value and scales it according to the programmed range.

Example 2: with a quadratic input range from 4 to 20 mA it is desired to have a linear read-out going from 0.0 to 500.0 (l/h).

Pushing \blacktriangle or \blacktriangledown push-button select the RNG ($\sqrt{\quad}$) scaling type.

Push the FUNC push-button, the display will show the following:

```
L . RNG XXXXX  mA
L . RNG XXXXXX EU
```

By the numerical keyboard, set the desired initial scale value (from Example 2, this value is equal to 4.000 mA).

NOTES:

- 1) The value assigned to "H.RANGE mA" must be higher than the value assigned to "L.RANGE mA" parameter.
- 2) The value assigned to "H.RANGE EU" parameter must be different from the value assigned to "L.RANGE EU".

When conditions 1 or 2 are not satisfied, the instrument will reject the new value showing the "0" and it will maintain the cursor on the rejected parameter.

- 3) The value assigned to "H.RANGE EU" parameter can be lower than the value assigned to "L.RANGE EU" (reverse read-out).

Push the FUNC push-button; the cursor will go automatically on the lower line.

By the numerical keyboard, set the desired read-out assigned to the initial scale value (for Example 2 this value is equal to 0.0 l/h).

Depress the FUNC push-button.

NOTES:

- 1) The displayed range will only be represented with positive numbers.
- 2) The instrument selects the 20 mA input range.
- 3) For the read-out in eng. units, the number of decimal figures is free with respect of the read-out limits (20000 counts).

The display will show the following:

H . RNG	XXXXXX	X	mA
H . RNG	XXXXXX		EU

By the numerical keyboard, set the desired final scale value (For Example 2, this value is equal to 20.000 mA).

Push the FUNC push-button; the cursor will go automatically on the lower line.

By the numerical keyboard, set the desired read-out assigned to the final scale value (for Example 2, this value is equal to 500.0l/h).

NOTE: For the read-out in eng. units, the number of decimal figures will be equal to the decimal figure assigned to "L.RANGE EU".

Push the FUNC push-button.

The instrument will start to measure .

For example 2, if a signal equal to 9.718 mA is applied to the input terminal the display will show:

MEAS	TX (√)
298.9	EU

NOTES:

- 1) During a TX measurement it is possible to enable/disable, by the REV/MOD push-button, the scaling function and to display the measured value in mA.
- 2) During TX measurement, the instrument is able to measure and display up to 5 % more than the upper programmed value or 5% less than the lower programmed value.

3.6 - mV MEASUREMENT.

CONNECTION FOR mV MEASUREMENTS

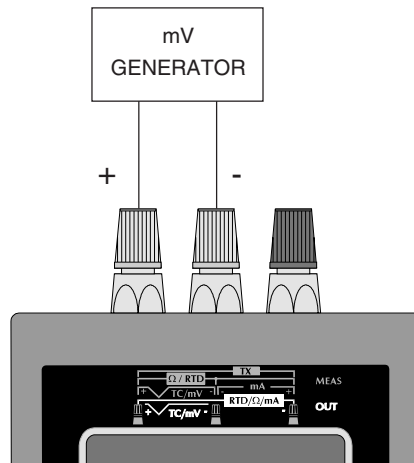

NOTE: The input impedance of the MEMOCAL 2000 is:
- up to 2 V, the input imp. is > 10 M Ω
- from 2 V to 20 V, the input imp. is = 500 k Ω .

HOW TO MEASURE A mV SIGNAL

Push the MEAS push-button; the display will show:

```
MEAS
TC RTD mA mV TX
```

Pushing \blacktriangle or \blacktriangledown push-button select the "mV" input type.
Push the FUNC push-button; the display will show the following:

```
NON - RANGEABLE
RNG(L)  RNG( $\sqrt{\quad}$ )
```

Where:

NON - RANGEABLE

allows to select a mV measurement without scaling (with a read-out in mV).

RNG(L)

allows to select a mV input with linear scaling on the read-out (the read-out is expressed in engineering unit and not in mV).

RNG($\sqrt{\quad}$)

allows to select a mV input with square root extraction on the measured value and programmable read-out scale in engineering units.

3.6.1 - NON RANGEABLE - mV measurement without scaling

Pushing ▲ or ▼ push-button, select the NON RANGEABLE input type.

The display will show:

```
20  200  2000
20000  AUTO
```

Where :

20, 200, 2000 , 20000

show that a fix range is desired.

These values are selectable and have the following significance:
20mV, 200mV, 2000mV, 20000mV f.s.

When a fixed range is selected the instrument will use a fix decimal figures.

AUTO

indicates that the instrument automatically selects the proper input range in order to measure the input signal with the max. possible resolution.

Pushing ▲ or ▼ push-button select the desired input range (e.g. AUTO)

Push the FUNC push-button.

The instrument starts measuring and the display will show:

```
MEAS      AUTO
XXXXXX mV
```

Where:

MEAS indicates that the instrument is performing a measurement.

AUTO shows that the autoranging function is selected.

mV is the engineering unit.

XXXXX shows the measured value.

3.6.2 - RNG(L) mV measurement with linear read-out scaling.

The **RNG(L)** selection allows to associate to an input range the desired read-out range.

Example 1: with a linear input range from 0 V to 10 V it is desired to have a read-out going from -100.0 to 1000.0 (mBar).

Pushing ▲ or ▼ push-button, select the RNG (L) function.

Push the FUNC push-button, the display will show the following:

```
L . RNG XXXXX X mV
L . RNG XXXXXX EU
```

By the numerical keyboard, set the desired initial scale value (For Example 1, this value is equal to 0 mV).

NOTES:

- 1) The value assigned to "H.RANGE mV" must be higher than the value assigned to "L.RANGE mV" parameter.
- 2) The value assigned to "H.RANGE EU" parameter must be different from the value assigned to "L.RANGE EU".

When conditions 1 or 2 are not satisfied, the instrument will reject the new value showing the "0" and it will maintain the cursor on the rejected parameter.

3) The value assigned to "H.RANGE EU" parameter can be lower than the value assigned to "L.RANGE EU" (reverse read-out). Push the FUNC push-button; the cursor will go automatically on the lower line.

By the numerical keyboard, set the desired read-out assigned to the initial scale value (For Example 1, it is equal to -100.0 mBar). Depress the FUNC push-button.

NOTES: For the read-out in eng. units, the number of decimal figures is free with respect of the read-out limits (20000 counts). The display will show the following:

```
H . RNG XXXXXX X mV
H . RNG XXXXXX EU
```

By the numerical keyboard, set the desired final scale value (For Example 1, this value is equal to 10000 mV). Push the FUNC push-button.

By the numerical keyboard, set the desired read-out assigned to the final scale value (For Example 1 this value is equal to 1000.0 mBar).

Push the FUNC push-button.

NOTE For the read-out in eng. units, the number of decimal figures will be equal to the decimal figure programmed in "L.RNG EU".

The instrument will start to measure and, for Example 1, if a 3 V signal is applied to the input terminal the display will show:

```
MEAS      RNG (L) mV
229.9 EU
```

NOTES:

- 1) The instrument will automatically select the input range containing the two programmed values ("L.RANGE mV" and "H.RANGE mV") with the maximum resolution.
- 2) During mV measurement with programmable read-out scaling it is possible to enable/disable, by the REV/MOD push-button, the scaling function and to display the measured value in mV.
- 3) During mV measurement, the instrument is able to measure and display up to 5 % more than the upper programmed value or 5% less than the lower programmed value.

3.6.3 - RNG ($\sqrt{\quad}$) - mV measurement with square root extraction on the measured value and read-out scaling.

Selecting the **RNG ($\sqrt{\quad}$)** option, the instrument extracts the square root of the measured value and scales it according to the programmed range.

Example 2 : with a quadratic input range from 1 to 5 V it is desired to have a read-out going from 0.0 to 1500.0 (m²/h).

Pushing ▲ or ▼ push-button, select the RNG($\sqrt{\quad}$) function.
Push the FUNC push-button, the display will show the following:

```
L . RNG XXXXX $\sqrt{\quad}$  mV
L . RNG XXXXXX EU
```

By the numerical keyboard, set the desired initial scale value (For Example 2 it is equal to 1000 mV).

NOTES:

- 1) The value assigned to "H.RANGE mV" must be higher than the value assigned to "L.RANGE mV" parameter.
- 2) The value assigned to "H.RANGE EU" parameter must be different from the value assigned to "L.RANGE EU".

When conditions 1 or 2 are not satisfied, the instrument will reject the new value showing the "0" and it will maintain the cursor on the rejected parameter.

- 3) The value assigned to "H.RANGE EU" parameter can be lower than the value assigned to "L.RANGE EU" (reverse read-out).

Push the FUNC push-button; the cursor will go automatically on the lower line.

By the numerical keyboard, set the desired read-out assigned to the initial scale value (For Example 2, it is equal to 0.0 m³/h).
Depress the FUNC push-button.

NOTES:

- 1) The input range may contain negative values.
- 2) The displayed range will only be represented with positive numbers.

The display will show the following:

```
H . RNG XXXXX $\sqrt{\quad}$  mV
H . RNG XXXXXX EU
```

By the numerical keyboard, set the desired final scale value (For Example 2 it is equal to 5000 mV).

Push the FUNC push-button.

By the numerical keyboard, set the desired read-out assigned to the final scale value (For Example 2 it is equal to 1500.0 (m³/h)).
Push the FUNC push-button.

NOTE For the read-out in eng. units, the number of decimal figures will be equal to the decimal figure programmed in "L.RNG EU".

The instrument will start to measure and, for Example 2, if a 4.5 V signal is applied to the input terminal the display will show:

```
MEAS          RNG ( $\sqrt{\quad}$ ) mV
1402.7 EU
```

NOTES:

- 1) The instrument will automatically select the input range containing the two programmed values ("L.RANGE mV" and "H.RANGE mV") with the maximum resolution.
- 2) During mV measurement with programmable read-out scaling it is possible to enable/disable, by the REV/MOD push-button, the



scaling function and to display the measured value in mV.

- 3) During mV measurement, the instrument is able to measure and display up to 5 % more than the upper programmed value or 5% less than the lower programmed value.

3.7 - OHM MEASUREMENTS

CONNECTION FOR OHM MEASUREMENTS

The short circuit between terminals B and C may be made:

- A) close to the instrument; in this case the measured value is equal to the line resistance plus the sensor resistance (i.e. potentiometer).
- B) close to the sensor; in this case, the measured value will be equal to the sensor resistance only.

The instrument is able to compensate a line resistance up to 100 Ohm/wire.

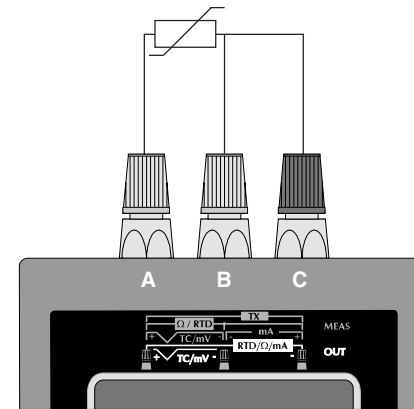

HOW TO MEASURE A RESISTANCE

Push MEAS push-button; the display will show the following:

```
MEAS
TC RTD mA mV TX
```

By pushing ▲ or ▼ push-button, select the RTD input type.

Push the FUNC push-button; the display will show:

```
Pt 100 Ni 100
Ohm
```

By pushing ▲ or ▼ push-button, select OHM.

Depress the FUNC push-button; the display will show the following:

```
MEAS      Ohm
XXXXXXXXX Ω
```

where:

MEAS shows that the instrument is performing a measurement

Ohm shows that the instrument is performing an Ω measurement.

Ω shows the engineering unit.

XXXXXXXXX shows the measured value in engineering unit.

3.8 TC SIMULATION

NOTE: The instrument will operate in accordance to the selected temperature standard (ITS-68 or ITS-90) (see paragraph "2.3 INSTRUMENT CONFIGURATION").

CONNECTION FOR TC SIMULATION USING INTERNAL RJ

For all TC simulations it is suggested to connect the extension cables directly to the instrument connectors without any additional plug. If plugs are required, it is necessary to use gold plated banana plugs in order to avoid not desired junction effects between cables and plug material.

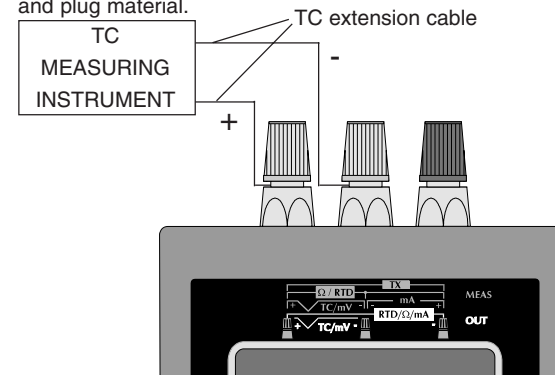

NOTE: when it is desired to exclude the cold junction compensation, select the external compensation and set a value equal to 0 °C or 32 °F.

CONNECTION FOR TC SIMULATION USING EXTERNAL RJ
 When it is desired to simulate a TC and an external stable reference junction box is used, connect the copper cable of the stable reference junction box to the instrument and set the external reference junction compensation value as show below.

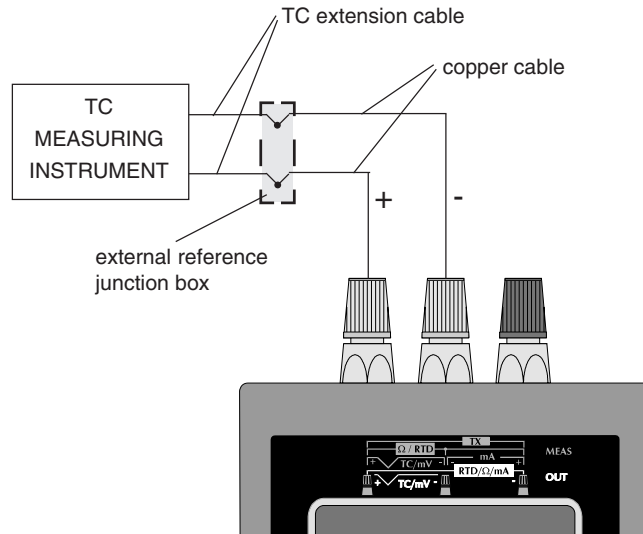

HOW TO SIMULATE A TC SENSOR

Depress the OUT push-button, the display will show the following:

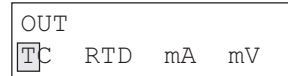

By ▲ or ▼ push-buttons select the "TC" sensor.

Push the FUNC push-button; the display will show the following:



By depressing the ▲ or ▼ push-buttons select the desired TC type (e.g. J).

NOTE: when ITS-90 is selected, the TC type U and L are not available so that the instrument will show these two TC types with a small letter and it does not allow to select them by jumping the two symbols during the cursor scrolling.

Depress the FUNC push-button again the display will show the following:



By pushing the ▲ or ▼ push-buttons select the desired engineering unit (e.g. °C).

Push the FUNC push-button; the display will show the following:

```
CJ INT
CJ EXT XXXXX
```

Depressing the ▲ or ▼ push-button, select the desired cold junction compensation type (external or internal) (e.g. INT).

NOTE

A) When the internal cold junction compensation has been selected, the instrument uses an internal RTD to compensate the ambient temperature (from 0 to 45 °C or from 32 to 113 °F).

B) If, otherwise, the external cold junction compensation has been selected, the instrument requires to insert the external reference junction compensation value (the temperature of the external reference junction compensation box).

This value can be programmed:

- from -20 °C to +80 °C or -4.0 °F to 176.0 °F for TC type J, K, T, E, R, S, U, L, PLII;
- from 0 °C to 80 °C or from 32 °F to 176 °F for TC type B, N, Ni/Ni18%Mo, W, W3 and W5 .

By the numerical keyboard, set the desired compensation value (if no value is inserted, the instrument will use a value equal to 0 °C or 32 °F according to the engineering unit previously selected).

Push the FUNC push-button, the instrument will show the following:

```
OUT 68J E 25.0
      X °C
```

where:

- OUT shows that the instrument is performing a generation
- 68 shows that the selected standard is the IPTS-68
- J shows that the instrument simulates a TC J.
- E shows that an external compensation is selected.
- 25.0 shows the selected compensation value.
- XXXXX this field will show the generated value in engineering units.

Type the value to be generated.

Push the FUNC push-button.

3.9 RTD SIMULATION

NOTE: The instrument will operate in accordance to the selected temperature standard (IPTS-68 or ITS-90) (see paragraph "2.3 INSTRUMENT CONFIGURATION").

CONNECTION FOR RTD SIMULATION

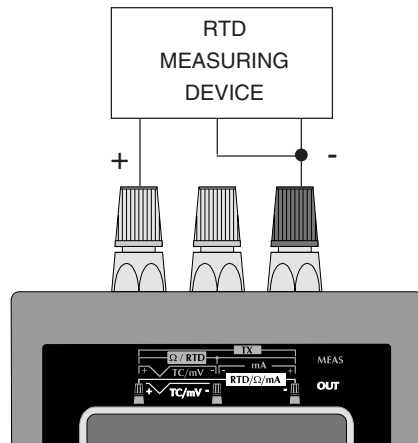

NOTE: the measuring current must be higher than 100 μ A and lower than 2 mA and the polarity must be equal to the indication shown in the drawing otherwise the instrument will generate an error message (see chapter "ERROR MESSAGES").

HOW TO SIMULATE AN RTD SENSOR

Push OUT push-button; the display will show the following:

```
OUT
TC RTD mA mV
```

By pushing ▲ or ▼ push-button, select the "RTD" sensor. Push the FUNC push-button; the display will show:

```
Pt100 Ni100
Ohm
```

By pushing ▲ or ▼ push-button, select the desired RTD type (e.g. Ni100).

NOTE: when ITS-90 is selected, the RTD type Ni 100 is not available so that the instrument will show this RTD with small letters and it does not allow to select it.

Push the FUNC push-button; the display will show the following:

```
ENGINEERING UNIT
°C °F
```

Depressing ▲ or ▼ push-button, select the desired engineering unit (e.g. °C).

Depress the FUNC push-button; the display will show the following:

```
OUT 68 Ni100
XXXXX °C
```

where:

- OUT shows that the instrument is performing a simulation
- 68 shows that the selected standard is the IPTS-68
- Ni100 shows that the simulated sensor is an RTD Ni 100.
- XXXXX it shows the simulated value.
- °C shows the selected engineering unit.

Type the value to be generated.

Push the FUNC push-button.

3.9 - mA GENERATION.

CONNECTION FOR mA GENERATION

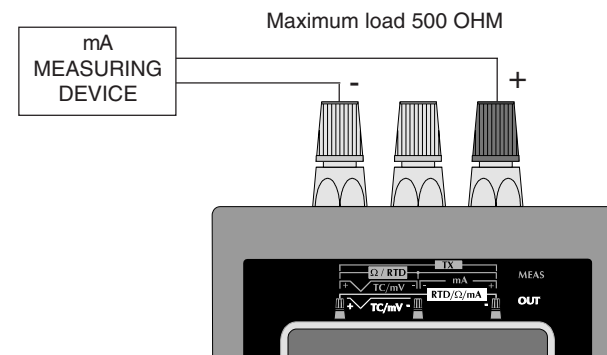

HOW TO GENERATE A mA SIGNAL

Push the OUT push-button; the display will show:

```
OUT
TC RTD mA mV
```

Pushing ▲ or ▼ push-button select the "mA" output type.
Push the FUNC push-button; the display will show the following:

```
20 mA UP TO RL=
100Ω 200Ω 500Ω
```

By this screen it is possible to select the maximum load applied to the instrument during mA generation. Select the minimum range encompassing the impedance of the instrument under test in order to reduce the power consumption of the MEMOCAL.
When the load is unknown, select the 500 Ω in order to assure the maximum compatibility.

NOTE: When the instrument operates without AC adapter, the first range (100 Ω) is limited to 50 Ω maximum.
The other ranges have not additional limits.

Pushing ▲ or ▼ push-button select the desired output load and push the FUNC push-button.
The display will show the following:

```
NON - RANGABLE
RNG (L)  RNG (QUAD)
```

Where:

NON - RANGEABLE

allows to select a mA generation without scaling (with a read-out in mA).

RNG(L)

allows to select a mA output with read-out scaling (the selection of the value to be generated will be made in engineering unit and not in mA).

RNG(QUAD)

allows to obtain a quadratic mA output with programmable read-out scale in engineering units (the selection of the value to be generated will be made in engineering unit and it will be linear while the resulting output will be quadratic).

3.9.1 - NON RANGEABLE - mA generation without scaling

Pushing ▲ or ▼ push-button, select the NON RANGEABLE output type.

Push the FUNC push-button.

The display will show:

```
OUT          20 mA
XXXXX mA
```

Where:

OUT indicates that the instrument is performing a generation.

20 mA show the selected range.

mA is the engineering unit.
XXXXX shows the generated value.

NOTE: the OUT 20 mA NON RANGEABLE selection allows to set (and to generate) a value up to 21.000 mA.

3.9.2 - RNG(L) linear mA generation with read-out scaling.

The **RNG(L)** selection allows to associate to a read-out range a linear mA output (the selection of the value to be generated will be made in engineering unit and not in mA).

Example 1 : with a read-out range from 0.0 to 100.0 (kg/cm²) it is desired to obtain a linear output from 0 to 20 mA.

Pushing ▲ or ▼ push-button, select the RNG (L) function.
Push the FUNC push-button, the display will show the following:

```
L . RNG XXXXX X mA
L . RNG XXXXXX EU
```

By the numerical keyboard, set the desired initial scale value (For Example 1, this value is equal to 4.000 mA).

NOTES:

- 1) The value assigned to "H.RANGE mA" must be higher than the value assigned to "L.RANGE mA" parameter.
- 2) The value assigned to "H.RANGE EU" parameter must be different from the value assigned to "L.RANGE EU".

When conditions 1 or 2 are not satisfied, the instrument will reject the new value showing the "0" and it will maintain the cursor on the rejected parameter.

3) The value assigned to "H.RANGE EU" parameter can be lower than the value assigned to "L.RANGE EU" (reverse read-out). Push the FUNC push-button; the cursor will go automatically on the lower line.

By the numerical keyboard, set the desired read-out assigned to the initial scale value (For Example 1, it is equal to 0.0 kg/cm²). Depress the FUNC push-button.

NOTES: For the read-out in eng. units, the number of decimal figures is free with respect of the read-out limits (20000 counts). The display will show the following:

```
H . RNG XXXXX X mA
H . RNG XXXXXX EU
```

By the numerical keyboard, set the desired final scale value (For Example 1, this value is equal to 20.000 mA). Push the FUNC push-button.

By the numerical keyboard, set the desired read-out assigned to the final scale value (For Example 1 this value is equal to 100.0 kg/cm²).

Push the FUNC push-button.

NOTES:

- 1) For the read-out in eng. units, the number of decimal figures will be equal to the decimal figure programmed in "L.RANGE EU".
- 2) During a mA generation with programmable read-out scaling, it is possible to enable/disable, by the REV/MOD push-button, the scaling function and to display the generated value in mA.

The instrument will show:

OUT	RNG (L)	mA
XXXXXX	X	EU

By the numerical keyboard, set the value to be generate.
Push the FUNC push-button, the instrument start immediately to generate.

3.9.3 - RNG (QUAD) - mA generation with quadratic output and linear read-out scaling.

Selecting the **RNG (QUAD)** option, the value to be generated will be set in engineering unit and it will be linear while the resulting output will follow quadratic curve.

Example 2 : with a quadratic output range from 4 to 20 mA it is desired to have a read-out going from 5.00 to 200.00 (m³/h).

Pushing ▲ or ▼ push-button, select the RNG(QUAD) function.
Push the FUNC push-button, the display will show the following:

L . RNG	XXXXXX	X	mA
L . RNG	XXXXXX		EU

By the numerical keyboard, set the desired initial scale value (For Example 2 it is equal to 4.000 mA).

NOTES:

- 1) The value assigned to "H.RANGE mA" must be higher than the value assigned to "L.RANGE mA" parameter.
- 2) The value assigned to "H.RANGE EU" parameter must be different from the value assigned to "L.RANGE EU".

When conditions 1 or 2 are not satisfied, the instrument will reject the new value showing the "0" and it will maintain the cursor on the rejected parameter.

- 3) The value assigned to "H.RANGE EU" parameter can be lower than the value assigned to "L.RANGE EU" (reverse read-out).

Push the FUNC push-button; the cursor will go automatically on the lower line.

By the numerical keyboard, set the desired read-out assigned to the initial scale value (For Example 2, it is equal to 5.00 m³/h.)
Depress the FUNC push-button.

NOTES: The displayed range will only be represented with positive numbers.

The display will show the following:

```
H . RNG XXXXX  mA
H . RNG XXXXXX EU
```

By the numerical keyboard, set the desired final scale value (For Example 2 it is equal to 20.000 mA).

Push the FUNC push-button.

By the numerical keyboard, set the desired read-out assigned to the final scale value (For Example 2 it is equal to 200.00 m³/h).

NOTES:

- 1) For the read-out in eng. units, the number of decimal figures will be equal to the decimal figure programmed in "L.RNG EU".
- 2) For the read-out in eng. units, the number of decimal figures is free with respect of the read-out limits (20000 counts).
- 3) During mA generation with programmable read-out scaling it is possible to enable/disable, by the REV/MOD push-button, the scaling function and to display the generation value in mA.

Push the FUNC push-button; the display will show:

```
OUT  RNG (QUAD) mA
XXXXX  EU
```

By the numerical keyboard, set the value to be generate.

Push the FUNC push-button, the instrument start immediately to generate.

3.10 - TX SIMULATION

NOTE: we define as TX all the 2, 3 or 4 -wire transmitters with 20 mA output capability.

CONNECTION FOR 2-WIRE TX SIMULATION.

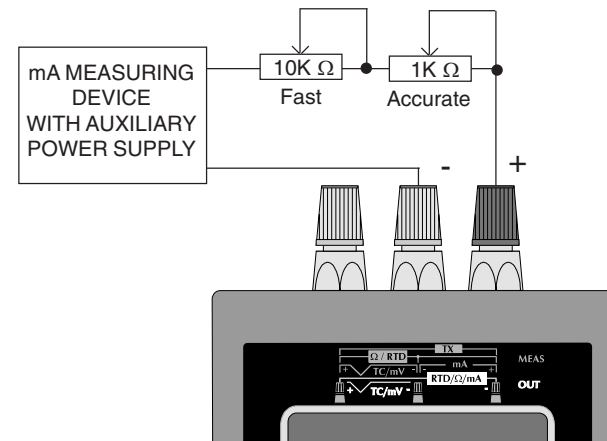

For both potentiometers it is suggested to utilize 10 turn, 2 W, linear potentiometers with the resistance shown in figure.

NOTE FOR 3 OR 4-WIRE TX SIMULATION

When a 3 or 4 wire TX simulation is required, it is sufficient to ignore the power supply of the instrument under test and to connect and program the calibrator as for standard mA generation (see chapter 3.9).

HOW TO EXECUTE A 2-WIRE TX SIMULATION.

Push the MEAS push-button; the display will show:

```
MEAS
TC RTD mA mV TX
```

Pushing ▲ or ▼ push-button select the "mA" input type.
Push the FUNC push-button; the display will show the following:

```
NON - RANGEABLE
RNG (L)  RNG (√)
```

Where:

NON - RANGEABLE

allows to select a mA measurement without scaling (with a read-out in mA).

RNG(L)

allows to select a mA input with read-out scaling (the read-out is expressed in engineering unit and not in mA).

RNG(√)

allows to select a mA input with square root extraction on the measured value and programmable read-out scale in engineering units.

3.10.1 -NON RANGEABLE - TX simulation without scaling

Example 1: it is desired to simulate a 2-wire, 4 to 20 mA transmitter while the "mA measuring device with auxiliary power supply" is programmed for a read-out going from -10.000 to 10.000 (m/s).

Pushing ▲ or ▼ push-button, select the NON RANGEABLE input type.

Push the FUNC push-button.

The display will show:

```
20 200
AUTO
```

Where :

20, 200 show the selectable 20mA, 200mA fix ranges.

Note: the 200 mA is limited at 130 mA.

When a fixed range is selected the instrument will use a fix decimal figures.

AUTO

indicates that the instrument automatically selects the proper input range in order to measure the input signal with the max. possible resolution.

Pushing ▲ or ▼ push-button select the desired input range (e.g. AUTO)

Push the FUNC push-button.

The instrument starts measuring and the display will show:

```
MEAS      AUTO
XXXXXX mA
```

Where:

MEAS indicates that the instrument is performing a measurement.

AUTO shows that the autoranging function is selected.

XXXXX shows the measured value.

mA is the engineering unit.

The two potentiometers allow to change the load of the instrument under test in order to make the measuring current equal to the desired value while the MEMOCAL 2000 is used to measure, with high accuracy, the current in subject.

3.10.2 - RNG(L) TX simulation with read-out scaling.

The **RNG(L)** selection allows to associate to an input range in mA the desired read-out range.

Example 2: it is desired to simulate a 2-wire transmitter with a linear output range from 4 to 20 mA while the "mA measuring device with auxiliary power supply" is programmed for a read-out

going from 0.000 to 20.000 (rpm) and it is desired to have on the device and on the calibrator the same read-out scaling.

Pushing ▲ or ▼ push-button, select the RNG (L) function.

Push the FUNC push-button, the display will show the following:

```
L . RNG XXXXX mA
L . RNG XXXXXX EU
```

By the numerical keyboard, set the desired initial scale value (For Example 2, this value is equal to 4.000 mA).

NOTES:

- 1) The value assigned to "H.RANGE mA" must be higher than the value assigned to "L.RANGE mA" parameter.
- 2) The value assigned to "H.RANGE EU" parameter must be different from the value assigned to "L.RANGE EU".

When conditions 1 or 2 are not satisfied, the instrument will reject the new value showing the "0" and it will maintain the cursor on the rejected parameter.

- 3) The value assigned to "H.RANGE EU" parameter can be lower than the value assigned to "L.RANGE EU" (reverse read-out). Push the FUNC push-button; the cursor will go automatically on the lower line.

By the numerical keyboard, set the desired read-out assigned to the initial scale value (For Example 2, it is equal to 0.000 rpm).

Depress the FUNC push-button.

NOTES: For the read-out in eng. units, the number of decimal

figures is free with respect of the read-out limits (20000 counts).
The display will show the following:

```
H . RNG XXXXX  mA
H . RNG XXXXXX EU
```

By the numerical keyboard, set the desired final scale value (For Example 2, this value is equal to 20.000 mA).

Push the FUNC push-button.

By the numerical keyboard, set the desired read-out assigned to the final scale value (For Example 2 this value is equal to 20.000 rpm).

Push the FUNC push-button.

NOTE For the read-out in eng. units, the number of decimal figures will be equal to the decimal figure programmed in "L.RNG EU".

The instrument will start to measure and, for Example 2, if a 13 mA signal is applied to the input terminal the display will show:

```
MEAS      RNG (L) mA
11249 EU
```

NOTES:

- 1) The instrument will automatically select the input range containing the two programmed values ("L.RANGE mA" and "H.RANGE mA") with the maximum resolution.
- 2) During mA measurement with programmable read-out scaling it is possible to enable/disable, by the REV/MOD push-button, the

scaling function and to display the measured value in mA.

- 3) During mA measurement, the instrument is able to measure and display up to 5 % more than the upper programmed value or 5% less than the lower programmed value.

The two potentiometers allow to change the load of the instrument under test in order to make the measure of the MEMOCAL 2000 equal to the desired value and to verify the indication of the instrument under test.

3.10.3 - RNG ($\sqrt{\quad}$) - TX simulation with square root extraction and linear read-out scaling.

Selecting the **RNG ($\sqrt{\quad}$)** option, the instrument extracts the square root of the measured value and scales it according to the programmed range.

Example 3: it is desired to simulate a 2-wire transmitter with a quadratic output range from 4 to 20 mA the "mA measuring device with auxiliary power supply" is programmed for a read-out going from 5.00 to 200.00 (m³/h) but it is desired to have on the device and on the calibrator the same read-out scaling.

Pushing **▲** or **▼** push-button, select the RNG($\sqrt{\quad}$) function.
Push the FUNC push-button, the display will show the following:

L . RNG XXXXX \square mA
L . RNG XXXXXX EU

By the numerical keyboard, set the desired initial scale value (For Example 3 it is equal to 4.000 mA).

NOTES:

- 1) The value assigned to "H.RANGE mA" must be higher than the value assigned to "L.RANGE mA" parameter.
- 2) The value assigned to "H.RANGE EU" parameter must be different from the value assigned to "L.RANGE EU".

When conditions 1 or 2 are not satisfied, the instrument will reject the new value showing the "0" and it will maintain the cursor on the rejected parameter.

- 3) The value assigned to "H.RANGE EU" parameter can be lower than the value assigned to "L.RANGE EU" (reverse read-out).

Push the FUNC push-button; the cursor will go automatically on the lower line.

By the numerical keyboard, set the desired read-out assigned to the initial scale value (For Example 3, it is equal to 5.00 m³/h.)

Depress the FUNC push-button.

NOTES:

- 1) The input range may contain negative values.
- 2) The displayed range will only be represented with positive numbers.

The display will show the following:

H . RNG XXXXX \square mA
H . RNG XXXXXX EU

By the numerical keyboard, set the desired final scale value (For Example 3 it is equal to 20.000 mA).

Push the FUNC push-button.

By the numerical keyboard, set the desired read-out assigned to the final scale value (For Example 3 it is equal to 200.00 (m²/h). Push the FUNC push-button.

NOTES:

- 1) For the read-out in eng. units, the number of decimal figures will be equal to the decimal figure programmed in "L.RNG EU".
- 2) For the read-out in eng. units, the number of decimal figures is free with respect of the read-out limits (20000 counts).

The instrument will start to measure and, for Example 3, if a 7 mA signal is applied to the input terminal the display will show:

MEAS RNG ($\sqrt{\quad}$) mA
86.68 EU

NOTES:

- 1) The instrument will automatically select the input range containing the two programmed values ("L.RANGE mA" and "H.RANGE mA") with the maximum resolution.

- 2) During mA measurement with programmable read-out scaling it is possible to enable/disable, by the REV/MOD push-button, the scaling function and to display the measured value in mA.
- 3) During mA measurement, the instrument is able to measure and display up to 5 % more than the upper programmed value or 5% less than the lower programmed value.

3.11 - mV GENERATION.

CONNECTION FOR mV GENERATION

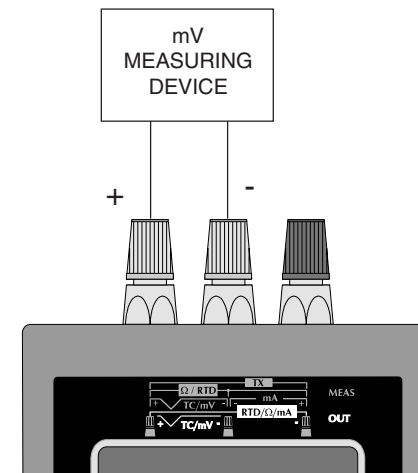

NOTE: The minimum load for mV generation is:
- up to 200 mV, it must be $> 1 \text{ M}\Omega$
- from 200 mV to 20 V, it must be $> 100 \text{ k}\Omega$.

HOW TO GENERATE A mV SIGNAL

Push the OUT push-button; the display will show:

```
OUT
TC RTD mA mV
```

Pushing ▲ or ▼ push-button select the "mV" output type.

Push the FUNC push-button; the display will show the following:

```
NON - RANGEABLE
RNG (L)  RNG (QUAD)
```

Where:

NON - RANGEABLE

allows to select a mV generation without scaling (the value to be generate will be set in mV).

RNG(L)

allows to select a mV output with linear scaling on the read-out (the value to be generated will be set in engineering unit and not in mV).

RNG(QUAD)

allows to select a mV output with quadratic output and programmable read-out scale in engineering units (the value to be generate will be set in engineering unit and it will be linear while the resulting output will be quadratic).

3.11.1 -NON RANGEABLE - mV generation without scaling

Pushing ▲ or ▼ push-button, select the NON RANGEABLE output type.

The display will show:

```
20 200 2000
20000 AUTO
```

Where :

20, 200, 2000 , 20000

show that a fix range is desired.

These values are selectable and have the following significance: 20mV, 200mV, 2000mV, 20000mV f.s.

When a fixed range is selected the instrument will use a fix decimal figures.

AUTO

indicates that the instrument automatically selects the proper output range in order to generate the programmed signal with the max. available accuracy.

Pushing ▲ or ▼ push-button select the desired output range (e.g. AUTO)

Push the FUNC push-button.

The instrument needs the value to be generate.

The instrument will show:

```
OUT AUTO mV
XXXXXX mV
```

Where:

OUT indicates that the instrument is performing a generation.

AUTO indicates the autoranging function.

XXXXX it shows the programmed value.

mV is the engineering unit.

By the numerical keyboard, set the value to be generate.

Push the FUNC push-button, the instrument start immediately to generate.

3.11.2 - RNG(L) mV generation with linear read-out scaling.

The **RNG(L)** selection allows to associate to a read-out range a desired linear output range.

Example 1: with a read-out going from -100.0 to 1000.0 (mB) it is desired to generate a linear output from 0 V to 10 V.

Pushing ▲ or ▼ push-button, select the RNG (L) function.

Push the FUNC push-button, the display will show the following:

```
L . RNG XXXXX  mV
L . RNG XXXXXX EU
```

By the numerical keyboard, set the desired initial scale value (For Example 1, this value is equal to 0 mV).

NOTES:

1) The value assigned to "H.RANGE mV" must be higher than the value assigned to "L.RANGE mV" parameter.

2) The value assigned to "H.RANGE EU" parameter must be different from the value assigned to "L.RANGE EU".

When conditions 1 or 2 are not satisfied, the instrument will reject the new value showing the "0" and it will maintain the cursor on the rejected parameter.

3) The value assigned to "H.RANGE EU" parameter can be lower than the value assigned to "L.RANGE EU" (reverse read-out).

Push the FUNC push-button; the cursor will go automatically on the lower line.

By the numerical keyboard, set the desired read-out assigned to the initial scale value (For Example 1, it is equal to -100.0 mB).

Depress the FUNC push-button.

NOTES: For the read-out in eng. units, the number of decimal figures is free with respect of the read-out limits (20000 counts).

The display will show the following:

```
H . RNG XXXXX  mV
H . RNG XXXXXX EU
```

By the numerical keyboard, set the desired final scale value (For Example 1, this value is equal to 10000 mV).

Push the FUNC push-button.

By the numerical keyboard, set the desired read-out assigned to the final scale value (For Example 1 this value is equal to 1000.0 mB).

Push the FUNC push-button.

NOTE For the read-out in eng. units, the number of decimal figures will be equal to the decimal figure programmed in "L.RNG EU".

The instrument will show:

OUT	RNG (L)	mV
XXXXXX	X	EU

By the numerical keyboard, set the value to be generate.
Push the FUNC push-button, the instrument start immediately to generate.

NOTES:

- 1) The instrument will automatically select the output range containing the two programmed values ("L.RANGE mV" and "H.RANGE mV") with the maximum resolution.
- 2) During mV generation with programmable read-out scaling it is possible to enable/disable, by the REV/MOD push-button, the scaling function and to display the generated value in mV.
- 3) During mV generation, the instrument is able to generate and display up to 5 % more than the upper programmed value or 5% less than the lower programmed value.

3.11.3 - RNG (QUAD) - mV generation with quadratic output and linear read-out scaling.

Selecting the **RNG (QUAD)** option, the value to be generated will be set in engineering unit and it will be linear while the resulting output will be quadratic.

Example 2 : with a linear read-out going from 0.0 to 1500.0 (m³/h) it is desired to obtain a quadratic output range from 1 to 5 V.
Pushing ▲ or ▼ push-button, select the RNG(QUAD) function.
Push the FUNC push-button, the display will show the following:

L . RNG	XXXXXX	X	mV
L . RNG	XXXXXX		EU

By the numerical keyboard, set the desired initial scale value (For Example 2 it is equal to 1000 mV).

NOTES:

- 1) The value assigned to "H.RANGE mA" must be higher than the value assigned to "L.RANGE mA" parameter.
- 2) The value assigned to "H.RANGE EU" parameter must be different from the value assigned to "L.RANGE EU".
When conditions 1 or 2 are not satisfied, the instrument will reject the new value showing the "0" and it will maintain the cursor on the rejected parameter.
- 3) The value assigned to "H.RANGE EU" parameter can be lower than the value assigned to "L.RANGE EU" (reverse read-out).

Push the FUNC push-button; the cursor will go automatically on the lower line.

By the numerical keyboard, set the desired read-out assigned to the initial scale value (For Example 2, it is equal to 0.0 m³/h).

Depress the FUNC push-button.

NOTES:

- 1) The output range may contain negative values.
- 2) The displayed range will only be represented with positive numbers.

The display will show the following:

```
H . RNG XXXXXX X mV
H . RNG XXXXXX EU
```

By the numerical keyboard, set the desired final scale value (For Example 2 it is equal to 5000 mV).

Push the FUNC push-button.

By the numerical keyboard, set the desired read-out assigned to the final scale value (For Example 2 it is equal to 1500.0 (m³/h)).

Push the FUNC push-button.

NOTES:

- 1) The instrument will automatically select the output range containing the two programmed values ("L.RANGE mV" and "H.RANGE mV") with the maximum resolution.
- 2) For the read-out in eng. units, the number of decimal figures will be equal to the decimal figure programmed in "L.RANGE EU".

- 3) By keeping depressed the ▲ and/or ▼ push-button it overimposes a ramp up or down to the generated value with a gradient of 2 LSD/second.
- 4) During a mV generation with programmable read-out scaling, it is possible to enable/disable, by the REV/MOD push-button, the scaling function and to display the generated value in mV.

The instrument will show:

```
OUT  RNG (QUAD) mV
XXXXX X EU
```

By the numerical keyboard, set the value to be generate.
Push the FUNC push-button, the instrument start immediately to generate.

3.12 - OHM SIMULATION

2-WIRE CONNECTION FOR OHM SIMULATION

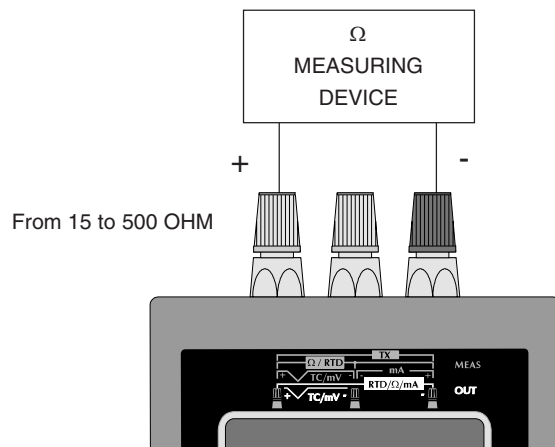

NOTE: for all ohm simulation, the measuring current must be higher than 100 μ A, lower than 2 mA and having the polarity shown in the figure; otherwise the instrument could show an error message (see chapter ERROR MESSAGES).

3-WIRE CONNECTION FOR OHM SIMULATION

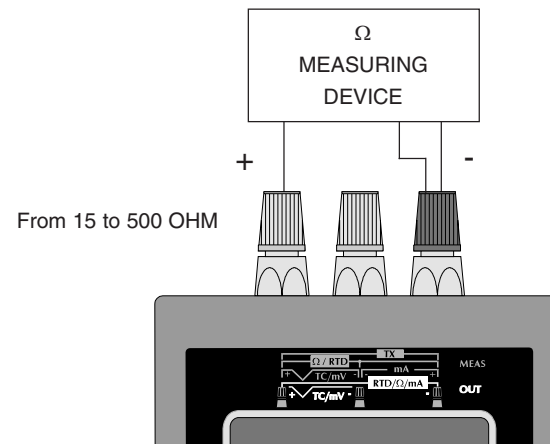

4-WIRE CONNECTION FOR OHM SIMULATION

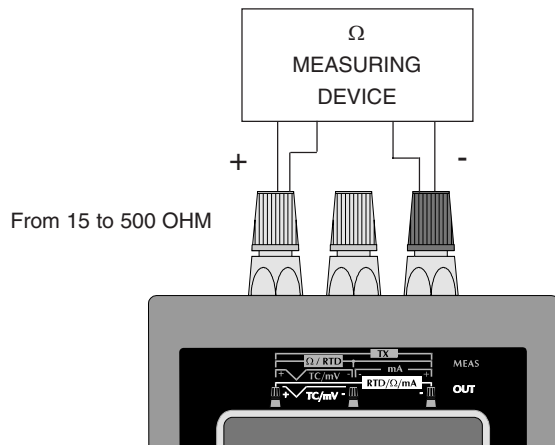

HOW TO SIMULATE A RESISTANCE

Push OUT push-button; the display will show the following:

```
OUT
TC RTD mA mV
```

By pushing ▲ or ▼ push-button, select the RTD input type.

Push the FUNC push-button; the display will show:

```
Pt 100 Ni 100
Ohm
```

By pushing ▲ or ▼ push-button, select OHM.

Depress the FUNC push-button; the display will show the following:

```
OUT Ohm
XXXXXXX Ω
```

where:

OUT shows that the instrument is performing a simulation.

Ohm shows that the instrument is performing an Ω simulation.

Ω shows the engineering unit.

XXXXXXX shows the programmed value in engineering unit.

Type the desired value.

Push the FUNC push-button.

The instrument start immediately to simulate.

SECTION 4 SEQUENTIAL FUNCTION ROUTINES

Up to 50 program steps can be further divided in one or more routines of different length.

4.1 -HOW TO CONSTRUCT AND STORE A NEW SEQUENTIAL FUNCTION ROUTINE.

Push the PROG push-button; the display will show:

```
PROGRAM N XX
YY FREE STEP(S)
```

where:

YY indicates how many program steps are still available.

XX enter in this field the identification code number of the routine to be created.

When it is desired to know the identification code already utilized, depress ▲ or ▼ push-buttons. On the lower display line will appear the identification code already in existence.

If the lower line is completely filled, depress ▲ or ▼ push-button again to scroll the remaining codes.

```
PROGRAM N XX
1 7 5 3 12 15
```

NOTE: the identification codes are sorted in chronological order and not in ascending order.

Type the desired identification code (e.g. 15) and then depress the FUNC push-button.

a) If the selected routine does not exist, the instrument will switch automatically to the EDIT mode.

b) If the selected routine exists, the display will show:

```
PROGRAM N 15
R UN EDIT DEL
```

In this case referred to the paragraph "2- how to modify a routine". The display will show the following:

```
PROGRAM N 15 01
MEAS OUT SBY STO
```

Where :

15 shows the identification code of the selected sequence

01 is the step number you are editing.

MEAS allows to insert a measurement step.

OUT allows to insert a generation step.

SBY allows to insert a "Stand-by" step.

STO allows to store, in the present step, the parameters of the "action" inserted prior to the editing of the sequential function routine.

NOTES:

A) When MEAS is selected, the instrument will execute the Selection Sequence described for measurement

B) When OUT is selected, the instrument will execute the Selection Sequence described for generation

In any of the above listed possibilities, at the end of the programming step, the display will show the programmed parameter set followed by the step number.

Example :

```

OUT      J  E  25.5
      150 °C      01
  
```

NOTE: no 90 or 68 indication are shown because the instrument will use, time by time during routine execution, the standard actually selected.

This represents a summary of all the just programmed parameters. Depress the FUNC push-button; the display will finally show:

```

TIME XX:XX      01
END VAL. [X]XXXXX
  
```

Where :

TIME in minutes and seconds (max. 99' 59"), shows the time duration of the just programmed step.

By setting 00:00 the instrument will wait for either an operator intervention (by pressing FUNC push-button) or logic input (RUN/WAIT) contact closure.

END VAL. This parameter is available for generation only and it allows to program a ramp.

END VAL. is the final value to be reached in the

programmed "TIME" frame.

- 1) When TIME = 00:00 the END VAL. cannot be modified therefore the program step should be necessarily a soak segment.
- 2) When TIME is different from 00:00, it is possible to set the END VAL. different from the Initial Value. In this case, the program step will be a ramp.
- 3) When TIME is different from 00:00, if the END VAL. is equal to initial value, the program step is going to be a soak segment and the TIME shows the time duration of the Soak.

NOTE: to return to the previous menu without memorizing the new selection, depress the SCRL BACK push-button. Depress the FUNC push-button; the instrument will switch to the new step having stored all the parameters previously set. Therefore, the display will show the following:

```

PROGRAM N 15      02
MEAS OUT SBY STO
  
```

Proceed now as described for the first step.

To define the end of the sequential function routine, depress the PROG push-button.

The instrument will memorize only the steps which have been completed properly and return to the STAND BY mode.

NOTE: During program editing, the I/O impedance of the instrument will be equal to 500 KOhm

4.2 - HOW TO MODIFY A ROUTINE.

Depress the PROG push-button; the display will show the following:

```
PROGRAM N   
YY FREE STEP(S)
```

Where:

YY indicates how many program steps are still available.

XX enter in this field the identification code number of the routine to be created, edited or run.

When it is desired to know the identification code already utilized, depress ▲ or ▼ push-buttons. On the lower display line will appear the ID. code already in existence.

If the lower line is completely filled, depress ▲ or ▼ push-button again to scroll the remaining codes.

```
PROGRAM N   
1 3 5 7 12 15
```

Type the ID. code of the routine to be modified and push the FUNC push-button.

The display will show the following:

```
PROGRAM N 15  
UN EDIT DEL
```

Where:

RUN enables the sequential function routine execution;

EDIT enables the EDIT mode of the selected routine;

DEL delete the selected routine.

When it is desired to delete the selected routine, select the DEL option and push the FUNC push-button.

The display will show the following:

```
PROG XX DELETE?  
 YES
```

Select YES and depress FUNC push-button. The instrument deletes the selected routine and returns automatically to the STAND BY mode.

By selecting NO the instrument returns to the previous menu.

When it is desired to modify the program, select EDIT and then depress FUNC push-button.

The display will show the following:

```
OUT J E 25.5  
150 °C 01
```

The display shows the first step parameters.

Four different situations may occur:

A) The first program step is correct.

Push the FUNC push-button; the display will show the following:

```
TIME XX:XX    01
END VAL. XXXXX
```

If no modifications are required, push the FUNC push-button again, the instrument goes to the next step.

- B) It is desired to delete the selected program step. Push the DEL/WAIT push-button. The instrument deletes all the data related with the selected step and renumbers the remaining steps.
- C) It is desired to modify one (or more) data of this step. Push the REV/MOD push-button. The instrument start the selection sequence. Insert all the parameters of this step.
NOTE: during routine editing, the instrument does not limit the TC or RTD selection in accordance with the actual standard selected (IPTS-68 or ITS 90) because it will use, time by time during routine execution, the selected standard.
- D) It is desired to insert a new program step between step (a) and step (b). Pushing the FUNC push-button and reach the program step (b). Push the Set up/ Ins push-button. The instrument renumbers the following steps and start the selection sequence.

NOTES:

- 1) To scroll back the selection sequence use the SCRL BACK push-button.

- 2) To end the EDIT mode of the sequential function routine, depress the PROG push-button. The instrument will memorize only the steps which have been properly completed and will return to the STAND BY mode.

4.3 - HOW TO RUN A ROUTINE.

Depress the PROG push-button; the display will show the following:

```
PROGRAM N XX
YY FREE STEP (S)
```

Type the desired program number (e.g. 18) and depress the FUNC push-button.

The display will show the following:

```
PROGRAM N 18
RUN EDIT DEL
```

Select RUN and push FUNC.

The display will show:

```
PROGRAM N 18
REPETITIONS N XX
```

Where XX is the number of routine repetitions.

NOTE: Setting a value equal to 00, the instrument repeats continu-

ously the selected routine (it is possible to stop the routine repetition pushing the ON/OFF push-button or the STAND BY push-button for more than 1.5 sec).

Type the desired repetition number and push FUNC push-button. The display will show the data of the executing step.

As an example:

OUT	J	E	25.5
	150	°C	01:XX

Where:

01 indicates the number of the step in execution.

XX indicates the number of repetition to be execute.

: flashing means that the program is in execution

NOTE: During routine execution a conflict may occur when the selected standard is equal to ITS-90 and the selected routine accomodates one or more steps with an RTD Ni100 or a TC type L or U linearization.

In these cases, when the program execution reaches a conflicting steps, the instrument will show the ERROR 5 indication.

To delete this error, depres the DEL/WAIT pushbuton, the instrument will use, only for this step, the IPTS-68 standard and it will continue the routine execution.

When the instrument is running a program it is possible:

1) To go to the next step by pushing the FUNC push-button.
2) To come back to the previous step by pushing SCRL BACK push-button.

3) To stop temporarily the routine execution by depressing the DEL/WAIT push-button or by RUN/WAIT digital input contact closure.

In WAIT mode the instrument stops time count and continues to perform the last operative function.

The step indication is flashing.

When the WAIT condition is enabled during a ramp generation, the instrument will maintain the output value actually generated.

NOTE: during WAIT mode the FUNC and SCRL BACK push-buttons maintain their functionality; in other words, they produce respectively a dump to the next or previous step of the routine but also the new step will be in WAIT condition.

To continue routine execution, push the DEL/WAIT push-button again.

To abort the routine execution, it is possible:

1) to keep down the STAND BY push-button for more than 1.5 seconds and go to the STAND BY mode.
2) to push twice the ON/OFF push-button.

At the end of routine execution, the instrument goes automatically to the STAND BY mode.

SECTION 5 ERROR MESSAGES

5.1 LOAD ERRORS

During OHM simulation, a reverse measuring current causes the "MISCON" indication on the display.

```

OUT      Ohm
MISCON  Ω
    
```

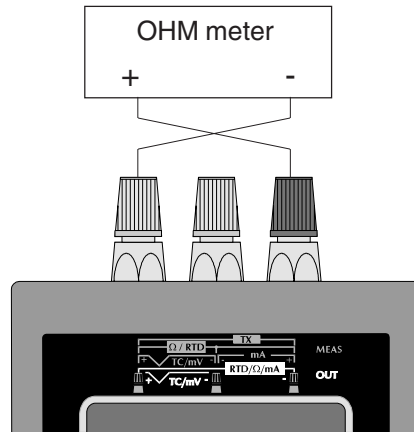

Revert the measuring wires.

During OHM simulation, a measuring current lower than 100 μA or higher than 2 mA can produce the following indication

```

OUT      Ohm
----- Ω
    
```

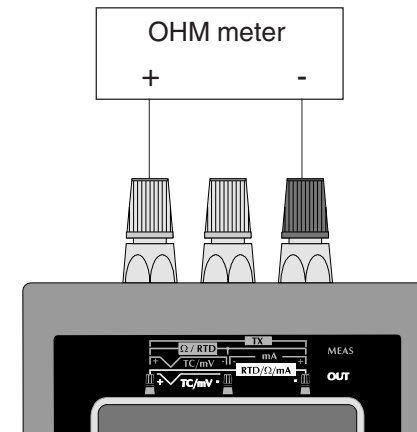

During TC and RTD measurement, if, during configuration procedure the open input test has been selected and the instrument detects an open circuit condition, it will show the following indication:

```
MEAS  K I 25.0
OPEN   °C
```

During mV, TC or mA generation, when an overload higher than 1% of the nominal value is detected, the instrument will show:

```
OUT      xx
-----  xx
```

NOTE: the instrument shows in the xx fields the selected engineering unit.

5.2 ERROR MESSAGES

The instrument performs, at instrument power up and during normal operativity, diagnostic controls.

Two type of errors may occur:

Not fatal errors (code 1, 2, 3, 4 or 5)

When a not fatal error is detected the instrument shows, on the lower row of the display, the "ERROR X !" messages where X is the error code.

If a not fatal error is detected it is possible to ignore the error

indication by pushing the DEL pushbutton but the accuracy of the instrument is not assured.

Fatal errors (code 6, 7 and 8)

When a fatal error is detected the instrument shows, on the lower row of the display, the "FATAL ERROR X !" messages where X is the error code.

If a fatal error is detected, switch OFF the instrument and then switch ON again.

In both cases, if the error persist send back the instrument to your supplier.

5.3 ERROR LIST

Not fatal errors

- 1 one of the configuration parameters is out of range
- 2 One of the zero calibration parameters is out of range
- 3 One of the initial or full scale calibration parameters is out of range
- 4 General error during calibration
- 5 Conflict between the selected temperature standard and sensor linearization.

Fatal errors

- 6 Write EEPROM error
- 7 Program path violation
- 8 Self test failure

SECTION 6 MAINTENANCE

6.1 POWER SUPPLY

For instrument power supply it is possible to use 4 battery AA size and/or the standard AC adapter.

Batteries can be rechargeable or non rechargeable types.

The rechargeable type can be:

- Ni/Cd (standard) 1,2 V cell with a capacity of 850 mA/h
- Ni/MH 1,2 V cell with a capacity of 1200 mA/h.

The non rechargeable type can be only ALKALINE 1,5 V cell.

The AC adapter has an output equal to 7,5 V with a maximum current equal to 1,2 A.

The AC adapter is capable to supply the instrument and, simultaneously, to recharge the batteries.

WARNING:

- 1) Before to connect the AC adapter to the instrument, set the battery type selector (see fig. 1) in accordance with the battery type inserted in the instrument.
- 2) Don't mix old batteries with new ones.
- 3) Don't use mixed battery types.

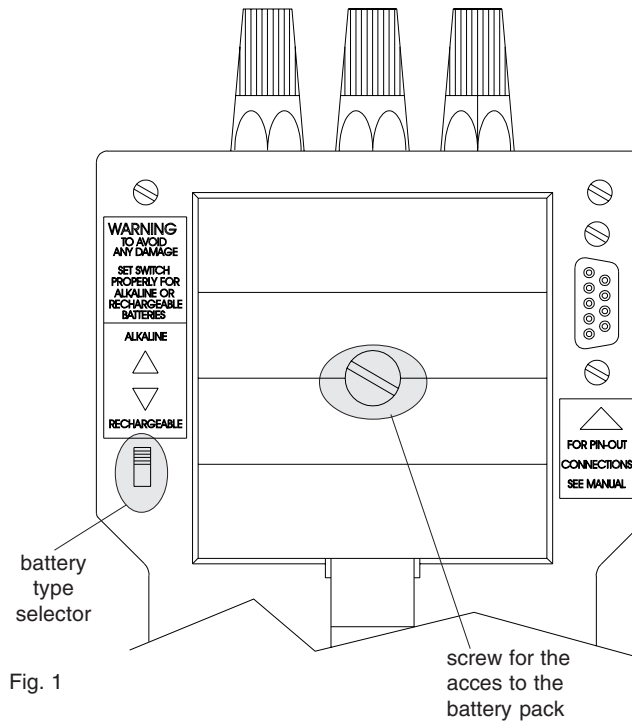

Fig. 1

6.2 BATTERY RECHARGE

This instrument is equipped with an AC adapter (see fig. 3) usable to recharge the batteries.

When the AC adapter is connected directly to the instrument (see fig. 2) and the battery type selector (see fig. 1) is set for rechargeable battery type, the batteries will be recharged in trickle charge mode.

Battery charge can be made with the instrument switched ON or OFF.

The trickle charge current is about 50 mA.

In trickle charge mode, a complete recharge can require up to:

- 12 hours for Ni/Cd cells;
- 20 hours for Ni/MH cells.

AC adapter direct connection

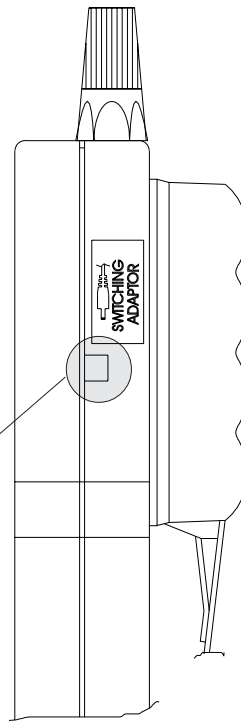

Fig. 2

The optional Desk-top-stand (see fig. 4) can provide a quick recharge mode.

The quick recharge current is equal to 250 mA.

In quick charge mode, a complete recharge can require up to:

- 3 hours for Ni/Cd cells;
- 5 hours for Ni/MH cells.

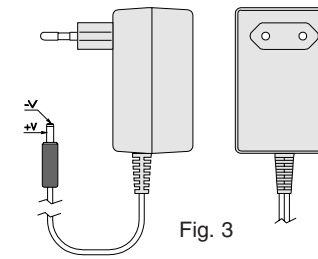

Fig. 3

NOTE: it is not advisable to make a frequent use of the quick charge mode (see chapter "Battery maintenance").

AC adapter connection through desk-top-stand

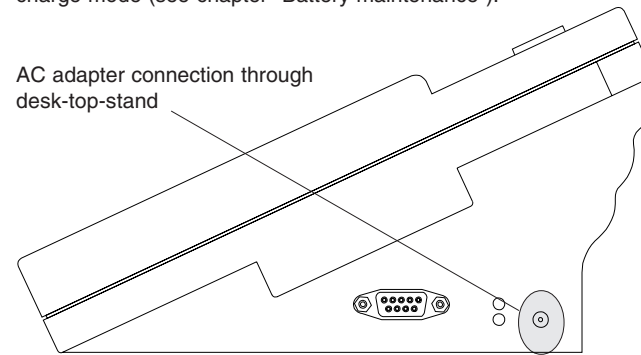

Fig. 4

6.3 BATTERY MAINTENANCE

The battery recharging system is optimized for the best battery life expectancy.

Any way, every 2 or 3 months it is suggested to discharge completely the battery pack leaving ON the instrument while it switch OFF automatically. Than recharge deeply for 24 hours with the AC adapter connected directly to the instrument.

6.4 BATTERY REPLACEMENT

When it is necessary to replace the battery pack, proceed as follows:

- 1) unscrew the battery cover (see fig. 1)
- 2) remove the battery cover
- 3) pull out the old batteries
- 4) insert the new batteries paying attention to the polarity.
- 5) set the battery type selector in accordance with the type of batteries inserted in the instrument.
- 6) reposition the battery cover
- 7) screw the battery cover.

WARNING:

- 1) After a battery replacement, set the battery type selector (see fig. 1) in accordance with the battery type inserted in the instrument.
- 2) Don't mix old batteries with new ones.
- 3) Don't use mixed battery types.

6.5 HOW TO CLEAN THE INSTRUMENT

To clean plastic, rubber, and external parts use only Alcohol:

- Ethyl (pure or denatured) [C₂H₅OH]
- Isopropil (pure or denatured) [(CH₃)₂CHOH]

6.6 INTERNAL FUSES

The instrument is protected by 2 pico fuses rated 1A, 125 V, quick acting (F) type.

The first one protects the power supply circuits.

The second one protects the input circuits.

WARNING: the fuse replacement can be made ONLY BY QUALIFIED PERSONNEL. IF ANY PROBLEM IS DETECTED, SEND THE INSTRUMENT TO LOCAL ERO ELECTRONIC BRANCH OFFICE OR REPRESENTATIVE.

6.7 INSTRUMENT MAINTENANCE

Every year it is advisable to verify the instrument accuracy.

This control must be made by a specialized metrology laboratory or directly by ERO factory in Novara.



Ero Electronic s.r.l.

Via E. Mattei, 21
28100 Novara
Italy

Tel. (+39) 0321-481111
Fax. (+39) 0321-481112

An Invensys Company

